

S-SERIES

NEW CONSTRUCTION

Window Sizes and Detail Drawings



IMPRESS THE WEATHER

Table of Contents

Window Sizes and Detail Drawings

S-Series - Single-Hung	1-3
S-Series - Double-Hung	4-6
Geometric Windows	7-8
Picture & Transom Windows	9-10
Casement Windows	11-15
Awning Windows	16
Sliding Windows	17-18
Bay & Bow Windows	19-20
Patio Doors	21-23
Trim Casing Options	24

Rough Opening			Single-Hung								
			20"	24"	28"	32"	36"	40"	44"	48"	52"
Unit Size			19½"	23½"	27½"	31½"	35½"	39½"	43½"	47½"	51½"
Sash Opening			13⅞"	17⅞"	21⅞"	25⅞"	29⅞"	33⅞"	37⅞"	41⅞"	45⅞"
Visible Glass-Sash			11⅜"	15⅜"	19⅜"	23⅜"	27⅜"	31⅜"	35⅜"	39⅜"	43⅜"
36"	35½"	13⅞"									
	SH2036	SH2436	SH2836	SH3236	SH3636	SH4036	SH4436	SH4836	SH5236		
44"	43½"	17⅞"									
	SH2044	SH2444	SH2844	SH3244	SH3644	SH4044	SH4444	SH4844	SH5244		
48"	47½"	19⅞"									
	SH2048	SH2448	SH2848	SH3248	SH3648	SH4048	SH4448	SH4848	SH5248		
52"	51½"	21⅞"									
	SH2052	SH2452	SH2852	SH3252	SH3652	SH4052	SH4452	SH4852	SH5252		
60"	59½"	25⅞"									
	SH2060	SH2460	SH2860	SH3260	SH3660	SH4060	SH4460	SH4860	SH5260		
66"	65½"	28⅞"									
	SH2066	SH2466	SH2866	SH3266	SH3666	SH4066	SH4466	SH4866	SH5266		
72"	71½"	31⅞"									
	SH2072	SH2472	SH2872	SH3272	SH3672	SH4072	SH4472	SH4872	SH5272		
80"	79½"	35⅞"									
	SH2080	SH2480	SH2880	SH3280	SH3680	SH4080	SH4480	SH4880	SH5280		

Single-Hung Vertical Detail

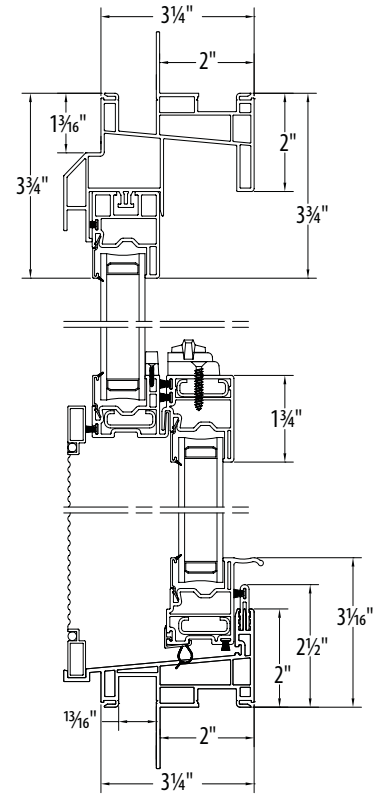

Callout sizes are expressed in inches and equal rough opening.

Single-hung windows have an interior frame depth of 2"; exterior projection of the frame is 1-3/16" from the nail fin.

When mulling a unit to a single-hung, overall rough opening is not affected by the mullion.

66" Tall windows are the maximum size available as oriels. Oriels are windows having 60% to 40% sash height proportions with the larger sash on top.

Reverse oriels have the smaller sash on top.

● Meets egress of:

- Clear opening area ≥ 5.7 sq. ft.
- Clear opening width ≥ 20"
- Clear opening height ≥ 24"

● All windows that can meet egress with egress hardware will automatically be manufactured to meet egress.

























● 2U1R2C: Mullied two-unit (one row, two columns).

● 2U2R1C: Mullied two-unit (two rows, one column).

□ Meets DP50 rating. Specify DP50 when ordering.

For the latest testing data, contact Customer Service or visit our website at www.viwinco.com

Single-Hung with Transom 2U2R1C[®] Vertical Detail

Rough Opening		Twin Single-Hung 2U1R2C [®]		
		56"	64"	72"
Unit Size		55½"	63½"	71½"
Sash Opening		21⅞"	25⅞"	29⅞"
Visible Glass-Sash		19⅜"	23⅜"	27⅜"
36"	35½"			
	13⅞"	SHSH5636	SHSH6436	SHSH7236
44"	43½"			
	17⅞"	SHSH5644	SHSH6444	SHSH7244
48"	47½"			
	19⅞"	SHSH5648	SHSH6448	SHSH7248
52"	51½"			
	21⅞"	SHSH5652	SHSH6452	SHSH7252
60"	59½"			
	25⅞"	SHSH5660	SHSH6460	SHSH7260
66"	65½"			
	28⅞"	SHSH5666	SHSH6466	SHSH7266
72"	71½"			
	31⅞"	SHSH5672	SHSH6472	SHSH7272
80"	79½"			
	35⅞"	SHSH5680	SHSH6480	SHSH7280

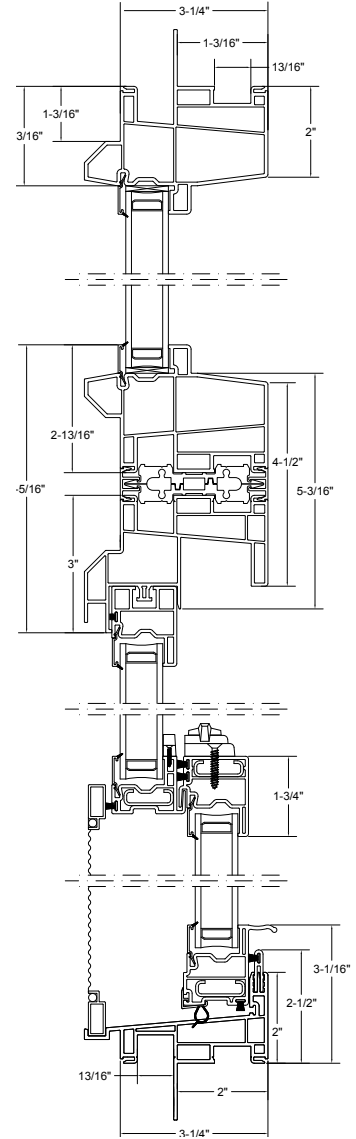

For transom sizes, see page 10

Twin Single-Hung 2U1R2C[®] Horizontal Detail

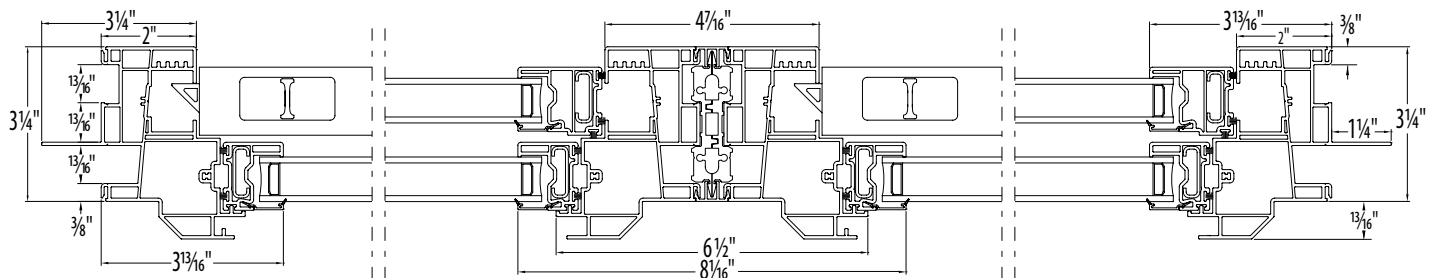

S-Series Single-Hung | Window Sizes and Detail Drawings

Rough Opening	Triple Single-Hung 3U1R3C [®]		
	84"	96"	108"
Unit Size	83½"	95½"	107½"
Sash Opening	21¾"	25¾"	29¾"
Visible Glass-Upper Sash	19¾"	23¾"	27¾"
Visible Glass-Lower Sash	19¾"	23¾"	27¾"
36"	35½"	35½"	35½"
	13¼"	13¼"	13¼"
44"	43½"	43½"	43½"
	17¼"	17¼"	17¼"
48"	47½"	47½"	47½"
	19½"	19½"	19½"
52"	51½"	51½"	51½"
	21¼"	21¼"	21¼"
60"	59½"	59½"	59½"
	25¼"	25¼"	25¼"
66"	65½"	65½"	65½"
	28¼"	28¼"	28¼"
72"	71½"	71½"	71½"
	31¼"	31¼"	31¼"
80"	79½"	79½"	79½"
	35¼"	35¼"	35¼"

Rough Opening	Single-Hung/Picture/Single-Hung 3U1R3C [®]			
	80"	92"	104"	124"
Unit Size	19½"	23½"	27½"	31½"
SHPXSH Unit Configuration	20-40-20	24-44-24	28-48-28	32-60-32
Sash Opening	13⅞"	17⅞"	21⅞"	25⅞"
Visible Glass-Sash	11⅞"	15⅞"	19⅞"	23⅞"
Visible Glass-Fixed Center	33¾"	37¾"	41¾"	53¾"
36"	35½"	19¾"	13⅞"	29¾"
	SHPXSH8036	SHPXSH9236	SHPXSH10436	SHPXSH12436
48"	47½"	19¾"	19⅞"	41¾"
	SHPXSH8048	SHPXSH9248	SHPXSH10448	SHPXSH12448
60"	59½"	25¾"	25⅞"	53¾"
	SHPXSH8060	SHPXSH9260	SHPXSH10460	SHPXSH12460

Callout sizes are expressed in inches and equal rough opening. Single-hung windows have an interior frame depth of 2" and an exterior projection of 1-3/16" from the nail fin. When mulling a unit to a single-hung, overall rough opening is not affected by the mullion. 66" Tall windows are the maximum size available as oriels. Oriels are windows having 60% to 40% sash height proportions with the larger sash on top. Reverse oriels have the smaller sash on top.

- 1 Meets egress of: Clear opening area ≥ 5.7 sq. ft. Clear opening width ≥ 20" Clear opening height ≥ 24"
- 2 3U1R3C: Mullied three-unit (one row, three columns).
- 3 All windows that can meet egress with egress hardware will automatically be manufactured to meet egress.

Meets DP50 rating. Specify DP50 when ordering. For the latest testing data, contact Customer Service or visit our website at www.Viwinco.com

Triple Single-Hung 3U1R3C[®] Horizontal Detail

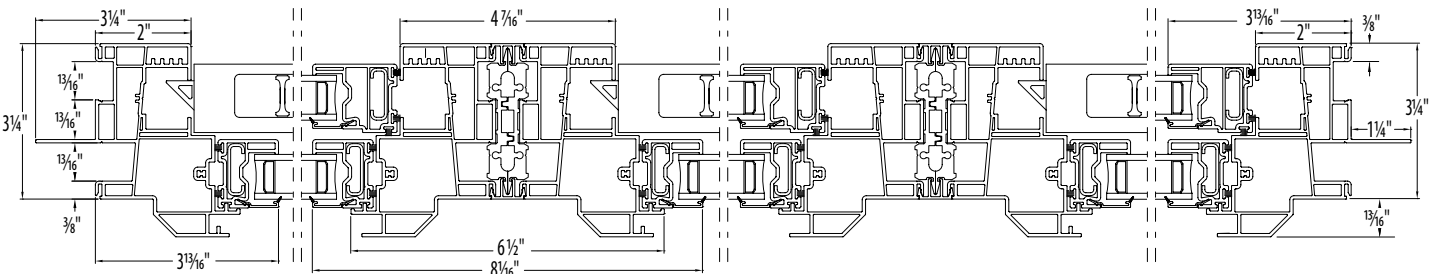

Single-Hung/Picture/Single-Hung 3U1R3C[®] Horizontal Detail

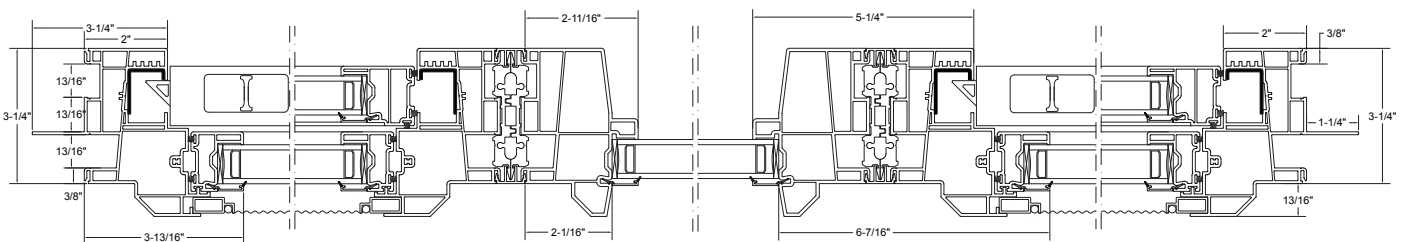

Rough Opening		Double-Hung								
		20"	24"	28"	32"	36"	40"	44"	48"	52"
Unit Size		19½"	23½"	27½"	31½"	35½"	39½"	43½"	47½"	51½"
Sash Opening		137/16"	177/16"	217/16"	257/16"	297/16"	337/16"	377/16"	417/16"	457/16"
Visible Glass-Upper Sash		11¾"	15¾"	19¾"	23¾"	27¾"	31¾"	35¾"	39¾"	43¾"
Visible Glass-Lower Sash		11¾"	15¾"	19¾"	23¾"	27¾"	31¾"	35¾"	39¾"	43¾"
36"	35½"									
	13¼"	DH2036	DH2436	DH2836	DH3236	DH3636	DH4036	DH4436	DH4836	DH5236
44"	43½"									
	17¼"	DH2044	DH2444	DH2844	DH3244	DH3644	DH4044	DH4444	DH4844	DH5244
48"	47½"									
	19½"	DH2048	DH2448	DH2848	DH3248	DH3648	DH4048	DH4448	DH4848	DH5248
52"	51½"									
	21¼"	DH2052	DH2452	DH2852	DH3252	DH3652	DH4052	DH4452	DH4852	DH5252
60"	59½"									
	25¼"	DH2060	DH2460	DH2860	DH3260	DH3660	DH4060	DH4460	DH4860	DH5260
62"	61½"									
	26¼"	DH2062	DH2462	DH2862	DH3262	DH3662	DH4062	DH4462	DH4862	DH5262
66"	65½"									
	28¼"	DH2066	DH2466	DH2866	DH3266	DH3666	DH4066	DH4466	DH4866	DH5266
72"	71½"									
	31¼"	DH2072	DH2472	DH2872	DH3272	DH3672	DH4072	DH4472	DH4872	DH5272
80"	79½"									
	35¼"	DH2080	DH2480	DH2880	DH3280	DH3680	DH4080	DH4480	DH4880	DH5280

Double-Hung Vertical Detail

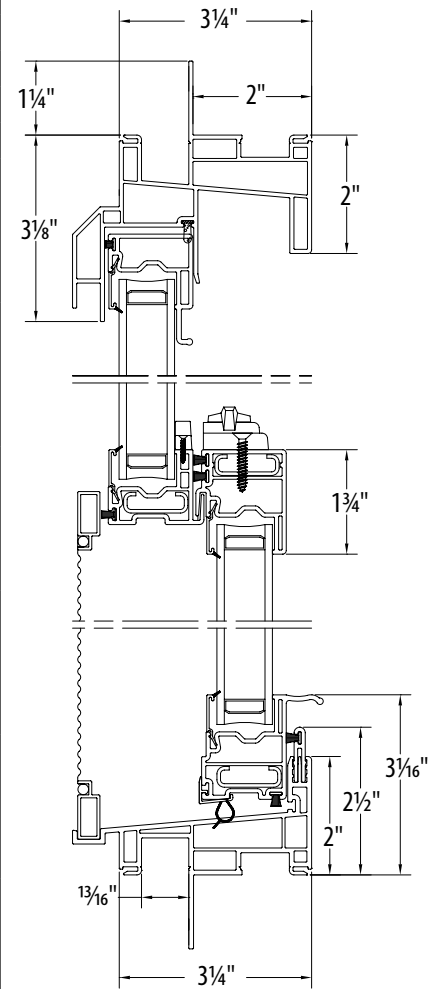

Callout sizes are expressed in inches and equal rough opening.

Double-hung windows have an interior frame depth of 2"; exterior projection of the frame is 1-3/16" from the nail fin.

When mulling a unit to a double-hung, overall rough opening is not affected by the mullion.

66" Tall windows are the maximum size available as oriels. Oriels are windows having 60% to 40% sash height proportions with the larger sash on top.

Reverse oriels have the smaller sash on top.

- Meets egress of:
Clear opening area ≥ 5.7 sq. ft.
Clear opening width ≥ 20"
Clear opening height ≥ 24"

- All windows that can meet egress with egress hardware will automatically be manufactured to meet egress.

- Meets DP50 rating. Specify DP50 when ordering.

For the latest testing data, contact Customer Service or visit our website at www.Viwinco.com

Rough Opening	Twin Double-Hung 2U1R2C [®]			
	56"	64"	72"	
Unit Size	55½"	63½"	71½"	
Sash Opening	21¾"	25¾"	29¾"	
Visible Glass-Upper Sash	19¾"	23¾"	27¾"	
Visible Glass-Lower Sash	19¾"	23¾"	27¾"	
36"	35½"	DHDH5636	DHDH6436	DHDH7236
	13¼"			
44"	43½"	DHDH5644	DHDH6444	DHDH7244
	17¼"			
48"	47½"	DHDH5648	DHDH6448	DHDH7248
	19¼"			
52"	51½"	DHDH5652	DHDH6452	DHDH7252
	21¼"			
60"	59½"	DHDH5660	DHDH6460	DHDH7260
	25¼"			
62"	61½"	DHDH5662	DHDH6462	DHDH7262
	26¼"			
66"	65½"	DHDH5666	DHDH6466	DHDH7266
	28¼"			
72"	71½"	DHDH5672	DHDH6472	DHDH7272
	31¼"			
80"	79½"	DHDH5680	DHDH6480	DHDH7280
	35¼"			





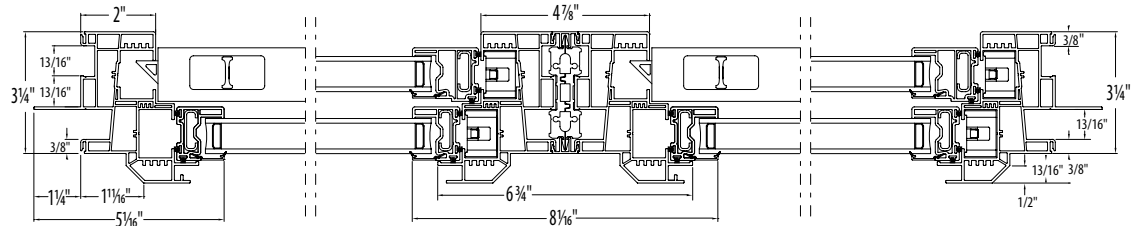



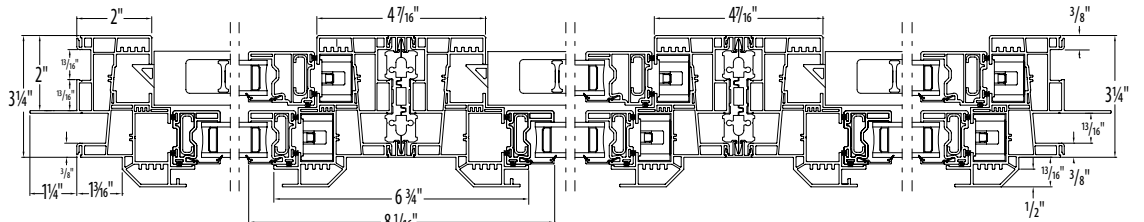

Rough Opening	Triple Double-Hung 3U1R3C [®]			
	84"	96"	108"	
Unit Size	83½"	95½"	107½"	
Sash Opening	21¾"	25¾"	29¾"	
Visible Glass-Upper Sash	19¾"	23¾"	27¾"	
Visible Glass-Lower Sash	19¾"	23¾"	27¾"	
36"	35½"	DHDHDH8436	DHDHDH9636	DHDHDH10836
	13¼"			
44"	43½"	DHDHDH8444	DHDHDH9644	DHDHDH10844
	17¼"			
48"	47½"	DHDHDH8448	DHDHDH9648	DHDHDH10848
	19¼"			
52"	51½"	DHDHDH8452	DHDHDH9652	DHDHDH10852
	21¼"			
60"	59½"	DHDHDH8460	DHDHDH9660	DHDHDH10860
	25¼"			
62"	61½"	DHDHDH8462	DHDHDH9662	DHDHDH10862
	26¼"			
66"	65½"	DHDHDH8466	DHDHDH9666	DHDHDH10866
	28¼"			
72"	71½"	DHDHDH8472	DHDHDH9672	DHDHDH10872
	31¼"			
80"	79½"	DHDHDH8480	DHDHDH9680	DHDHDH10880
	35¼"			

Twin Double-Hung 2U1R2C[®] Horizontal Detail



Triple Double-Hung 3U1R3C[®] Horizontal Detail

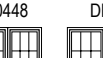

Rough Opening		Double-Hung /Picture/Double-Hung 3U1R3C [®]			
		80"	92"	104"	124"
Unit Size		79½"	91½"	103½"	123½"
DHPXDH Unit Configuration		20-40-20	24-44-24	28-48-28	32-60-32
Sash Opening		13⅜"	17⅜"	21⅜"	25⅜"
Visible Glass-Upper Sash		11¾"	15¾"	19¾"	23¾"
Visible Glass-Upper Center		33¾"	37¾"	41¾"	53¾"
Visible Glass-Fixed Lower		11¾"	15¾"	19¾"	23¾"
36"	35½"				
	—	13⅜"	13⅜"	29¾"	DHPXDH8036 DHPXDH9236 DHPXDH10436 DHPXDH12436
48"	47½"				
	—	19⅞"	19⅞"	41¾"	DHPXDH8048 DHPXDH9248 DHPXDH10448 DHPXDH12448
60"	59½"				
	—	25⅞"	25⅞"	53¾"	DHPXDH8060 DHPXDH9260 DHPXDH10460 DHPXDH12460

Double-Hung with Transom 2U2R1C[®]
Vertical Detail

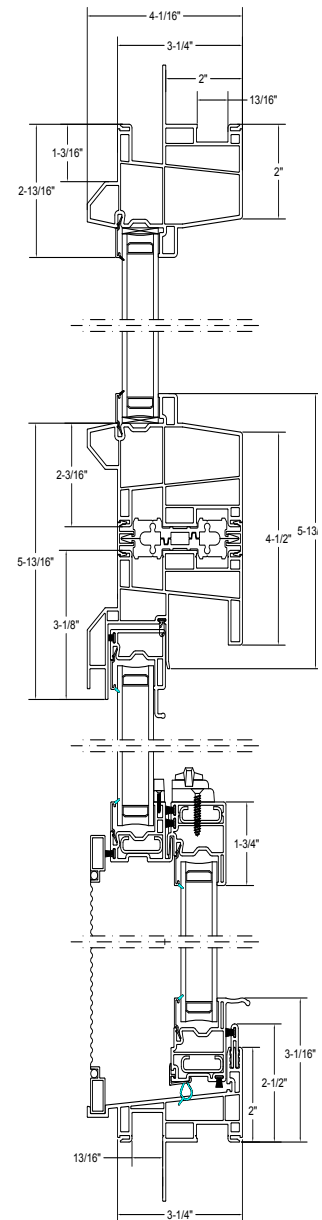

For transom sizes, see page 10

Double-Hung/Picture/Double-Hung 3U1R3C[®] Horizontal Detail

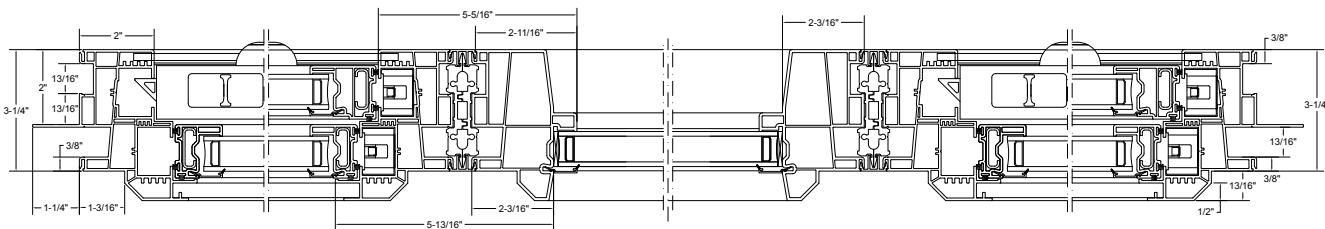

Callout sizes are expressed in inches and equal rough opening.

Double-hung windows have an interior frame depth of 2"; exterior projection of the frame is 1-3/16" from the nail fin.

When mulling a unit to a double-hung, overall rough opening is not affected by the mullion. 66" Tall windows are the maximum size available as oriels.

Oriels are windows having 60% to 40% sash height proportions with the larger sash on top. Reverse oriels have the smaller sash on top.

- Meets egress of:
Clear opening area ≥ 5.7 sq. ft.
Clear opening width ≥ 20"
Clear opening height ≥ 24"

● All windows that can meet egress with egress hardware will automatically be manufactured to meet egress.

● 2U1R2C: Mullied two-unit (one row, two columns).

● 3U1R3C: Mullied three-unit (one row, three columns).

● 2U2R1C: Mullied three-unit (one row, three columns).

☐ Meets DP50 rating. Specify DP50 when ordering.

For the latest testing data, contact Customer Service or visit our website at www.Viwinco.com

S-Series Geometrics | Window Sizes and Detail Drawings

Extended Arch and Eyebrow												
Chord Height	4 ³ / ₈ "	5 ¹ / ₈ "	5 ⁷ / ₈ "	6 ⁵ / ₈ "	7 ¹ / ₁₆ "	8 ¹ / ₈ "	9"	11 ¹ / ₄ "	13 ¹ / ₂ "	17 ¹³ / ₁₆ "		
Rough Opening	24"	28"	32"	36"	40"	44"	48"	60"	72"	96"		
Unit Width	23 ¹ / ₂ "	27 ¹ / ₂ "	31 ¹ / ₂ "	35 ¹ / ₂ "	39 ¹ / ₂ "	43 ¹ / ₂ "	47 ¹ / ₂ "	59 ¹ / ₂ "	71 ¹ / ₂ "	95 ¹ / ₂ "		
Series	Shoulder Height (NET)											
	Eyebrow											
A	7 ¹ / ₈ "											
Series	Extended Arch											
	B	19 ¹ / ₈ "										
	C	31 ¹ / ₈ "										
	D	39 ¹ / ₈ "										
	E	43 ¹ / ₈ "										
	F	47 ¹ / ₈ "										
	G	55 ¹ / ₈ "										
	H	61 ¹ / ₈ "										
	I	67 ¹ / ₈ "										
	J	79 ¹ / ₈ "										
	K	91 ¹ / ₈ "										

Grid patterns and styles

Series A: Eyebrow

Starburst pattern Available in deluxe or flat grids between the glass.

Maximum number of spokes: 5 Minimum width for 5 spokes: 60"

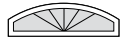

Starburst

Series B to K: Extended arch

Colonial pattern Available in deluxe or flat grids between the glass.

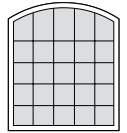

Colonial



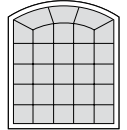







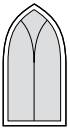
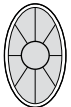
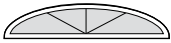

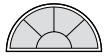

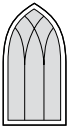
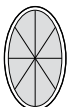

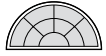

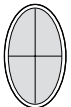
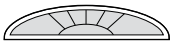

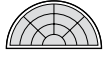
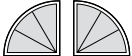

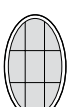

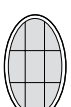
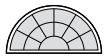

Cathedral pattern Available in deluxe or flat grids between the glass.

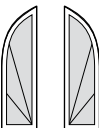
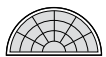

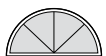
Cathedral

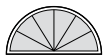
Series	Rough Opening Width									
	24"	28"	32"	36"	40"	44"	48"	60"	72"	96"
A	12"	12 ³ / ₈ "	13 ¹ / ₂ "	14 ¹ / ₄ "	15 ¹ / ₁₆ "	15 ³ / ₄ "	16 ³ / ₈ "	18 ³ / ₈ "	13 ³ / ₈ "	25 ¹ / ₁₆ "
B	24"	24 ³ / ₄ "	25 ¹ / ₂ "	26 ¹ / ₄ "	27 ¹ / ₁₆ "	27 ³ / ₄ "	28 ³ / ₈ "	30 ³ / ₈ "	33 ³ / ₈ "	37 ¹ / ₁₆ "
C	36"	36 ³ / ₄ "	37 ¹ / ₂ "	38 ¹ / ₄ "	39 ¹ / ₁₆ "	39 ³ / ₄ "	40 ³ / ₈ "	42 ³ / ₈ "	45 ¹ / ₈ "	
D	44"	44 ³ / ₄ "	45 ¹ / ₂ "	46 ¹ / ₄ "	47 ¹ / ₁₆ "	47 ³ / ₄ "	48 ³ / ₈ "	50 ³ / ₈ "	53 ¹ / ₈ "	
E	48"	48 ³ / ₄ "	49 ¹ / ₂ "	50 ¹ / ₄ "	51 ¹ / ₁₆ "	51 ³ / ₄ "	52 ³ / ₈ "	54 ³ / ₈ "	57 ¹ / ₈ "	
F	52"	52 ³ / ₄ "	53 ¹ / ₂ "	54 ¹ / ₄ "	55 ¹ / ₁₆ "	55 ³ / ₄ "	56 ³ / ₈ "	58 ³ / ₈ "	61 ¹ / ₈ "	
G	60"	60 ³ / ₄ "	61 ¹ / ₂ "	62 ¹ / ₄ "	63 ¹ / ₁₆ "	63 ³ / ₄ "	64 ³ / ₈ "	66 ³ / ₈ "		
H	66"	66 ³ / ₄ "	67 ¹ / ₂ "	68 ¹ / ₄ "	69 ¹ / ₁₆ "	69 ³ / ₄ "	70 ³ / ₈ "	72 ³ / ₈ "		
I	72"	72 ³ / ₄ "	73 ¹ / ₂ "	74 ¹ / ₄ "	75 ¹ / ₁₆ "	75 ³ / ₄ "	76 ³ / ₈ "			
J	84"	84 ³ / ₄ "	85 ¹ / ₂ "	86 ¹ / ₄ "	87 ¹ / ₁₆ "	87 ³ / ₄ "	88 ³ / ₈ "			
K	96"	96 ³ / ₄ "	97 ¹ / ₂ "	98 ¹ / ₄ "						

Rough opening height above equals shoulder height plus chord height plus 1/2".

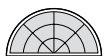
Circle	Gothic/ Half-Gothic	Oval/ Half-Oval	Elliptical	Octagon	Half-Round	Quarter-Round ^①
 Sunburst	 One-Stem Tracery ②	 Sunburst	 Starburst 3-Spoke	 Sunburst	 Sunburst ^③	 2-Spoke Sunburst
 Starburst ^②	 Two-Stem Tracery ②	 Starburst ^②	 Sunstar 5-Spoke ^④	 Colonial Four-Lite	 Double-Sunburst ^④	 2-Spoke Double-Sunburst ^④
 Colonial Four-Lite	Size Unit Dimensions GO1836 17½" x 35½" GO2040 19½" x 39½" GO2244 21½" x 43½" GO2448 23½" x 47½" GO2856 27½" x 55½" GO3060 29½" x 59½" GO3672 35½" x 71½"	 Starburst ^②	 Sunburst 5-Spoke ^⑤	 Colonial Nine-Lite	 Triple-Sunburst ^⑤	 2-Spoke Starburst
 Colonial Nine-Lite	Size Unit Dimensions CI2424 23½" x 23½" CI3030 29½" x 29½" CI3636 35½" x 35½"	 Colonial Four-Lite	Size Unit Dimensions EL6018 59½" x 17½" EL7220 71½" x 19½" EL8420 83½" x 19½" EL9620 95½" x 19½"	 Colonial Nine-Lite	 5-Spoke Sunburst ^⑥	 1-Spoke Sunstar
Size Unit Dimensions CI2424 23½" x 23½" CI3030 29½" x 29½" CI3636 35½" x 35½"	Half-Gothic	 Colonial Nine-Lite	For standard and custom orders, the maximum number of spokes is 5.	Size Unit Dimensions OT2424 23½" x 23½" OT3232 31½" x 31½" OT3636 35½" x 35½"	 5-Spoke Double-Sunburst ^⑦	 2-Spoke Sunstar
	 Starburst ^{①②}	Size Unit Dimensions OV2436 23½" x 35½" OV3656 35½" x 55½"			 5-Spoke Triple-Sunburst ^⑧	 1-Spoke Double-Sunstar ^⑨
	Size Unit Dimensions HGO1854 17½" x 53½" HGO2260 21½" x 59½" HGO2666 25½" x 65½" HGO2872 27½" x 71½"	Half-Oval			 Starburst	 2-Spoke Sunstar
		 Sunburst			 5-Spoke Starburst ^⑩	 2-Spoke Double-Sunstar ^⑩
		 Starburst			 Sunstar ^⑥	Size (LEFT) Unit Dimensions QRL2020 19½" x 19½" QRL2424 23½" x 23½" QRL2828 27½" x 27½" QRL3030 29½" x 29½" QRL3232 31½" x 31½" QRL3636 35½" x 35½"
		Size Unit Dimensions HOV2418 23½" x 17½" HOV3628 35½" x 27½"			 Double-Sunstar ^④	(left as viewed from outside)

Custom Shapes

Traditional rectangular, trapezoid, parallelogram, and other shapes utilizing fixed frames are available

Geometric Windows, Extended Arch and Eyebrow Horizontal Detail

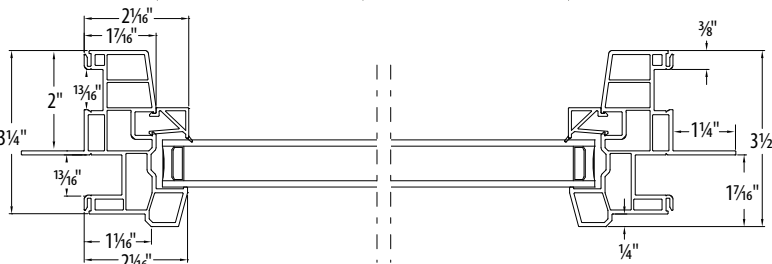

Size	Unit Dimensions
HR2412	23½" x 11½"
HR2814	27½" x 13½"
HR3015	29½" x 14½"
HR3216	31½" x 15½"
HR3618	35½" x 17½"
HR4020	39½" x 19½"
HR4422	43½" x 21½"
HR4824	47½" x 23½"
HR5628	55½" x 27½"
HR6030	59½" x 29½"
HR6432	63½" x 31½"
HR7236	71½" x 35½"
HR7437	73½" x 36½"

















































































For standard and custom orders, the maximum number of spokes is 5.































Fixed extended arch and eyebrow windows have an interior frame depth of 2" and an exterior projection from the nail fin of 1-3/4".
 Callout sizes are expressed in inches (width) and equal rough opening.
 Geometric windows have an interior frame depth of 2"; exterior projection of the frame is 1-3/16" from the nail fin.
 Callout sizes are expressed in inches (width x height) and equal rough opening.
 Unless otherwise noted, patterns are available in deluxe or flat grids between the glass.
Note: When geometric and picture windows are muller together, sightlines will not be even.

- ① Specify left-hand or right-hand as viewed from the exterior.
- ② Available with flat grids between the glass only.
- ③ Starburst, Sunburst, and Sunstar (5-spoke) patterns: minimum window size is 60" for either deluxe or flat grids.
- ④ Double-Sunburst and Double-Sunstar patterns: minimum window size is 48" for either deluxe or flat grids.
- ⑤ Sunstar and Sunburst (3-spoke) patterns: minimum window size is 28" for deluxe grids.
- ⑥ Triple-Sunstar and Triple-Sunburst patterns: minimum window size is 72" for either deluxe or flat grids.
- ⑦ All sizes shown meet DP50 rating.

For the latest testing data, contact Customer Service or visit our website at www.viwinco.com

Picture and Transom | Window Sizes and Detail Drawings

Rough Opening		Picture									
		12 1/2"	20"	24"	28"	32"	36"	40"	44"	48"	60"
Unit Size		12"	19 1/2"	23 1/2"	27 1/2"	31 1/2"	35 1/2"	39 1/2"	43 1/2"	47 1/2"	59 1/2"
Visible Glass		6 7/16"	13 3/4"	17 3/4"	21 3/4"	25 3/4"	29 3/4"	33 3/4"	37 3/4"	41 3/4"	53 3/4"
36"	35 1/2"										
	29 3/4"	PX12.536	PX2036	PX2436	PX2836	PX3236	PX3636	PX4036	PX4436	PX4836	PX6036
42"	41 1/2"										
	35 3/4"	PX12.542	PX2042	PX2442	PX2842	PX3242	PX3642	PX4042	PX4442	PX4842	PX6042
44"	43 3/4"										
	37 3/4"	PX12.544	PX2044	PX2444	PX2844	PX3244	PX3644	PX4044	PX4444	PX4844	PX6044
48"	47 1/2"										
	41 3/4"	PX12.548	PX2048	PX2448	PX2848	PX3248	PX3648	PX4048	PX4448	PX4848	PX6048
52"	51 1/2"										
	45 3/4"	PX12.552	PX2052	PX2452	PX2852	PX3252	PX3652	PX4052	PX4452	PX4852	PX6052
60"	59 1/2"										
	53 3/4"	PX12.560	PX2060	PX2460	PX2860	PX3260	PX3660	PX4060	PX4460	PX4860	PX6060
66"	65 1/2"										
	59 3/4"	PX12.566	PX2066	PX2466	PX2866	PX3266	PX3666	PX4066	PX4466	PX4866	PX6066
72"	71 1/2"										
	65 3/4"	PX12.572	PX2072	PX2472	PX2872	PX3272	PX3672	PX4072	PX4472	PX4872	PX6072

Rough Opening	Transom										
	28"	30"	32"	36"	40"	44"	48"	52"	56"	64"	72"
Unit Size	27½"	29½"	31½"	35½"	39½"	43½"	47½"	51½"	55½"	63½"	71½"
Visible Glass	21¾"	23¾"	25¾"	29¾"	33¾"	37¾"	41¾"	45¾"	49¾"	57¾"	65¾"
12 ½" 12" 6 7/16"											
	TSM2812.5	TSM3012.5	TSM3212.5	TSM3612.5	TSM4012.5	TSM4412.5	TSM4812.5	TSM5212.5	TSM5612.5	TSM6412.5	TSM7212.5
	18" 17½" 11¾"										
TSM2818		TSM3018	TSM3218	TSM3618	TSM4018	TSM4418	TSM4818	TSM5218	TSM5618	TSM6418	TSM7218
24" 23½" 17¾"											
	TSM2824	TSM3024	TSM3224	TSM3624	TSM4024	TSM4424	TSM4824	TSM5224	TSM5624	TSM6424	TSM7224

Picture & Transom
Vertical Detail

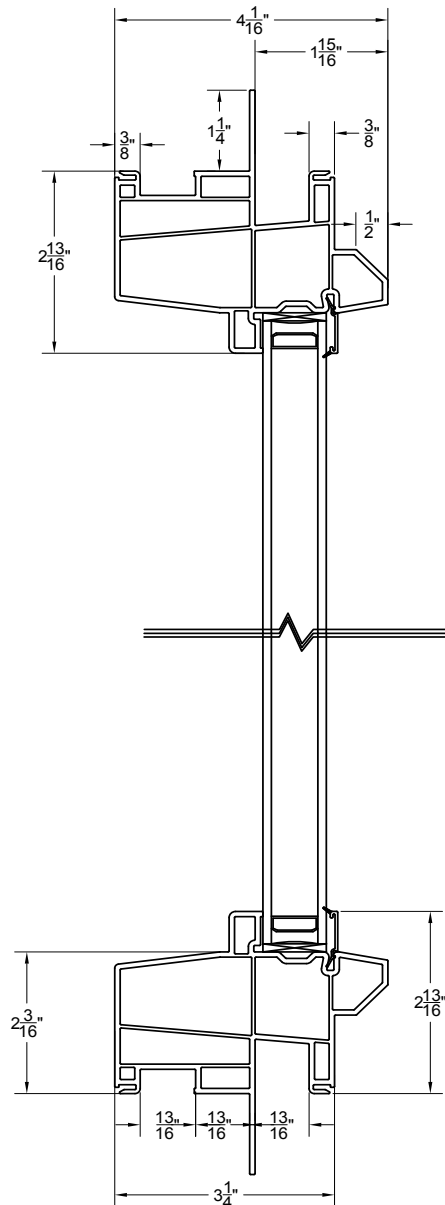













































Callout sizes are expressed in inches (width x height) and equal rough opening.

Picture and transom windows have an interior frame depth of 2"; exterior projection of the frame is 1-3/16" from the nail fin.

When mulling a unit to a picture or transom overall rough opening is not affected by the mullion.

Meets DP50 rating. Specify DP50 when ordering.

For the latest testing data, contact Customer Service or visit our website at www.Viwinco.com

Rough Opening	Casement					
	18"	20"	24"	28"	30"	36"
Unit Size	17½"	19½"	23½"	27½"	29½"	35½"
Sash Opening	4⅞"	6⅞"	10⅞"	14⅞"	16⅞"	22⅞"
Visible Glass-Sash	11¼"	13¼"	17¼"	21¼"	23¼"	29¼"
24"	 CX1824	 CX2024	 CX2424	—	—	—
36"	 CX1836	 CX2036	 CX2436	 CX2836	 CX3036	 CX3636
42"	 CX1842	 CX2042	 CX2442	 CX2842	 CX3042	 CX3642 2
48"	 CX1848	 CX2048	 CX2448	 CX2848	 CX3048 2	 CX3648 1
52"	 CX1852	 CX2052	 CX2452	 CX2852	 CX3052 2	 CX3652 1
60"	 CX1860	 CX2060	 CX2460	 CX2860	 CX3060 2	 CX3660 1
66"	 CX1866	 CX2066	 CX2466	 CX2866	 CX3066 2	 CX3666 1
72"	 CX1872	 CX2072	 CX2472	 CX2872	 CX3072 2	 CX3672 1

Casement Cross-Sectional Head & Sill Detail

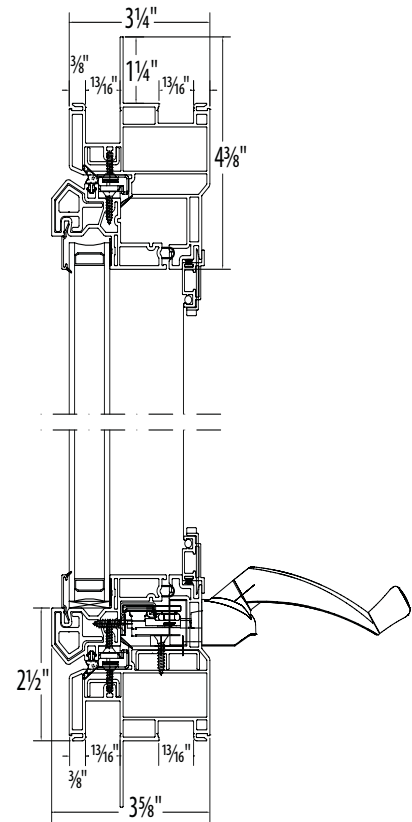

Rough Opening	Twin Casement				
	36"	40"	48"	56"	72"
Unit Size	35½"	39½"	47½"	55½"	71½"
Sash Opening	47⁄8"	67⁄8"	107⁄8"	147⁄8"	227⁄8"
Visible Glass-Sash	11¼"	13¼"	17¼"	21¼"	29¼"
24"	23½"	17¼"	17¼"	—	—
36"	35½"	29¼"	29¼"	—	—
42"	41½"	35¼"	35¼"	—	—
48"	47½"	41¼"	41¼"	—	—
52"	51½"	45¼"	45¼"	—	—
60"	59½"	53¼"	53¼"	—	—
66"	65½"	58¼"	58¼"	—	—
72"	71½"	65¼"	65¼"	—	—

Twin Casement Cross-Sectional Jamb Detail with Integral Mullion

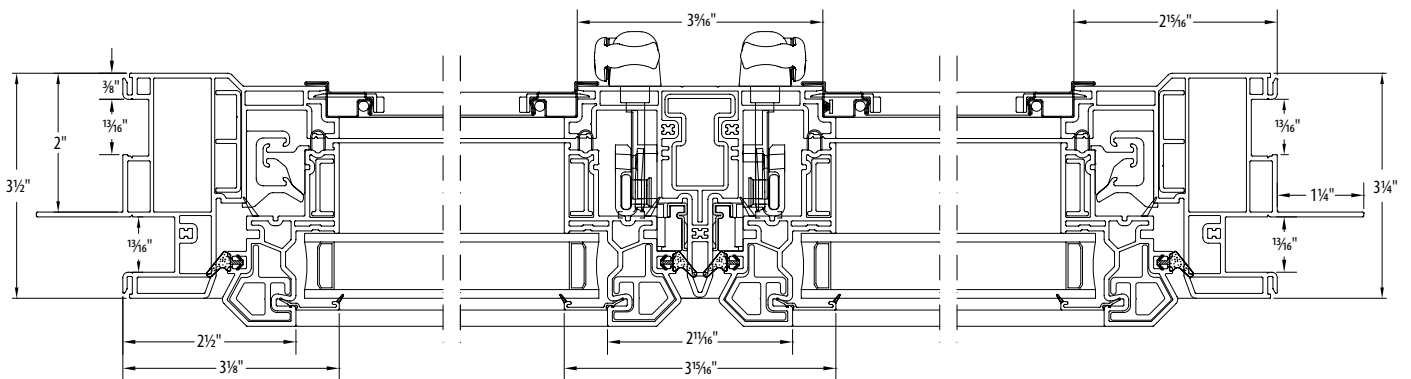

Callout sizes are expressed in inches and equal rough opening. Casement and awning windows have an interior frame depth of 2" and an exterior projection of 1-5/8" from the nail fin.

When mulling a unit to a casement, overall rough opening is not affected by the mullion.

- Meets egress of:
Clear opening area ≥ 5.7 sq. ft.
Clear opening width ≥ 20"
Clear opening height ≥ 24"
- All windows that can meet egress with egress hardware will automatically be manufactured to meet egress.

☐ Meets DP50 rating. Specify DP50 when ordering. For the latest testing data, contact Customer Service.

Colonial casement grid pattern option available for single casements and twin casement sizes.

Colonial casements are designed to mimic the look of double-hung and single-hung windows but offer the larger opening of a casement. To order: Single casement - use the callout prefix CCX. Twin casement - use the callout prefix TCCX.

Consult Customer Service for the exact grid pattern. Final grid layout to be approved by customer.

For the latest testing data, contact Customer Service or visit our website at www.viwinco.com

S-Series Casement | Window Sizes and Detail Drawings

Rough Opening	Quad Casement			
	72"	80"	96"	112"
Unit Size	71½"	79½"	95½"	111½"
Sash Opening	47⁄8"	67⁄8"	107⁄8"	147⁄8"
Visible Glass-Sash	11¼"	13¼"	17¼"	21¼"
24"	23½"	—	—	—
	17¼"	—	—	—
36"	35½"	—	—	—
	29¼"	—	—	—
42"	41½"	—	—	—
	35¼"	—	—	—
48"	47½"	—	—	—
	41¼"	—	—	—
52"	51½"	—	—	—
	45¼"	—	—	—
60"	59½"	—	—	—
	53¼"	—	—	—
66"	65½"	—	—	—
	58¼"	—	—	—
72"	71½"	—	—	—
	65¼"	—	—	—

Quad Casement Cross-Sectional Jamb Detail with Integral Mullions

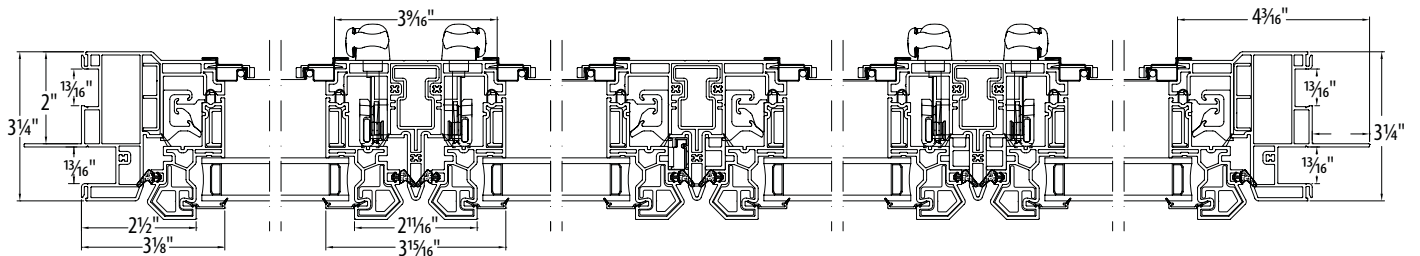

Rough Opening	Casement/Picture/Casement				
	54"	60"	72"	84"	108"
Unit Size	53½"	59½"	71½"	83½"	107½"
Sash Opening	47⅞"	6⅞"	10⅞"	14⅞"	22⅞"
Visible Glass-Sash	11¼"	13¼"	17¼"	21¼"	29¼"
24"	23½"	—	—	—	—
	17¼"	—	—	—	—
36"	35½"	—	—	—	—
	29¼"	—	—	—	—
42"	41½"	—	—	—	—
	35¼"	—	—	—	—
48"	47½"	—	—	—	—
	41¼"	—	—	—	—
52"	51½"	—	—	—	—
	45¼"	—	—	—	—
60"	59½"	—	—	—	—
	53¼"	—	—	—	—
66"	65½"	—	—	—	—
	58¼"	—	—	—	—
72"	71½"	—	—	—	—
	65¼"	—	—	—	—

Casement/Picture/Casement Cross-Sectional Jamb Detail with Integral Mullions

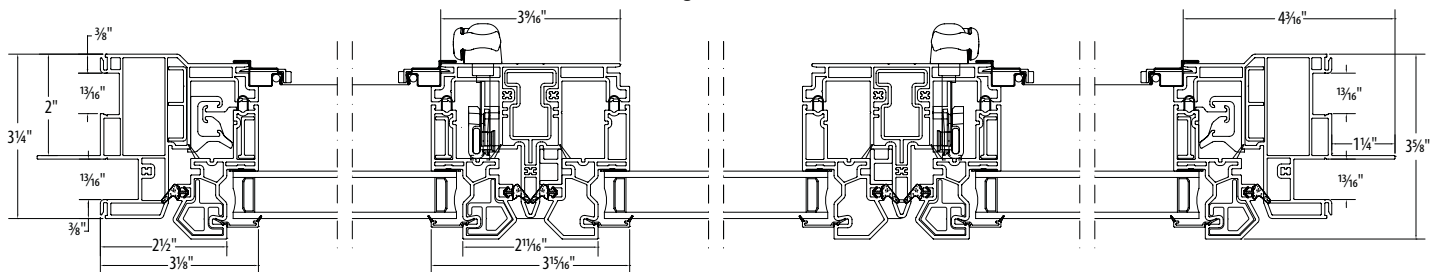

Callout sizes are expressed in inches and equal rough opening. Casement and awning windows have an interior frame depth of 2" and an exterior projection of 1-5/8" from the nail fin.

When mulling a unit to a casement, overall rough opening is not affected by the mullion.

- Meets egress of:
Clear opening area ≥ 5.7 sq. ft.
Clear opening width ≥ 20"
Clear opening height ≥ 24"
- All windows that can meet egress with egress hardware will automatically be manufactured to meet egress.

☐ Meets DP50 rating. Specify DP50 when ordering.





















































For the latest testing data, contact Customer Service.

Colonial casement grid pattern option available for single casements and twin casement sizes.

Colonial casements are designed to mimic the look of double-hung and single-hung windows but offer the larger opening of a casement. To order: Single casement - use the callout prefix CCX. Twin casement - use the callout prefix TCCX.

Consult Customer Service for the exact grid pattern. Final grid layout to be approved by customer.

For the latest testing data, contact Customer Service or visit our website at www.Viwinco.com

Rough Opening			Casement Picture Fixed							
			20"	24"	28"	30"	36"	42"	48"	60"
Unit Size			19½"	23½"	27½"	29½"	35½"	41½"	47½"	59½"
Visible Glass			13¼"	17¼"	21¼"	23¼"	29¼"	35¼"	41¼"	53¼"
36"	35½"	29¼"	 CPX2036	 CPX2436	 CPX2836	 CPX3036	 CPX3636	 CPX4236	 CPX4836	 CPX6036
	42"	41½"	35¼"	 CPX2042	 CPX2442	 CPX2842	 CPX3042	 CPX3642	 CPX4242	 CPX4842
48"	47½"	41¼"	 CPX2048	 CPX2448	 CPX2848	 CPX3048	 CPX3648	 CPX4248	 CPX4848	 CPX6048
	52"	51½"	45¼"	 CPX2052	 CPX2452	 CPX2852	 CPX3052	 CPX3652	 CPX4252	 CPX4852
60"	59½"	53¼"	 CPX2060	 CPX2460	 CPX2860	 CPX3060	 CPX3660	 CPX4260	 CPX4860	 CPX6060
	66"	65½"	59¼"	 CPX2066	 CPX2466	 CPX2866	 CPX3066	 CPX3666	 CPX4266	 CPX4866
72"	71½"	65¼"	 CPX2072	 CPX2472	 CPX2872	 CPX3072	 CPX3672	 CPX4272	 CPX4872	 CPX6072

Casement Picture (Fixed)
Cross-Sectional Head
and Sill Detail

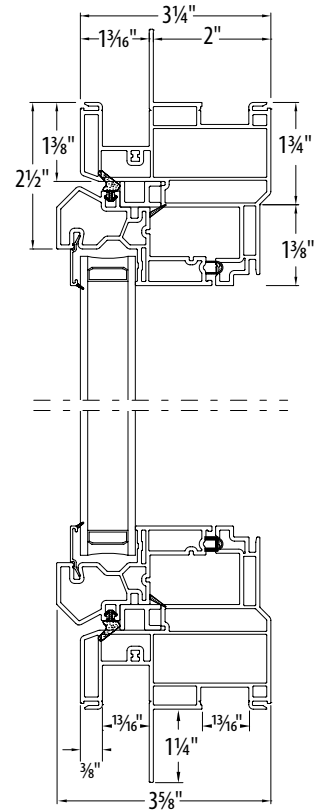





























Callout sizes are expressed in inches (width x height) and equal rough opening.

Casement picture windows have an interior frame depth of 2"; exterior projection of the frame is 1-3/16" from the nail fin.

When mulling a unit to a casement picture overall rough opening is not affected by the mullion.

Meets DP50 rating. Specify DP50 when ordering.

For the latest testing data, contact Customer Service or visit our website at www.viwinco.com

Rough Opening			Awning					
			24"	36"	40"	48"	56"	60"
Unit Size			23½"	35½"	39½"	47½"	55½"	59½"
Visible Glass			17¼"	29¼"	33¼"	41¼"	49¼"	53¼"
18"	17½"	11¼"	 AX2418	 AX3618	 AX4018	 AX4818	 AX5618	 AX6018
	20"	19½"	13¼"	 AX2420	 AX3620	 AX4020	 AX4820	 AX5620
24"	23½"	17¼"	 AX2424	 AX3624	 AX4024	 AX4824	 AX5624	 AX6024
28"	27½"	21¼"	 AX2428	 AX3628	 AX4028	 AX4828	 AX5628	 AX6028
36"	35½"	29¼"	 AX2436	 AX3636	 AX4036	 AX4836	 AX5636	 AX6036

Awning Cross-Sectional Jamb Detail

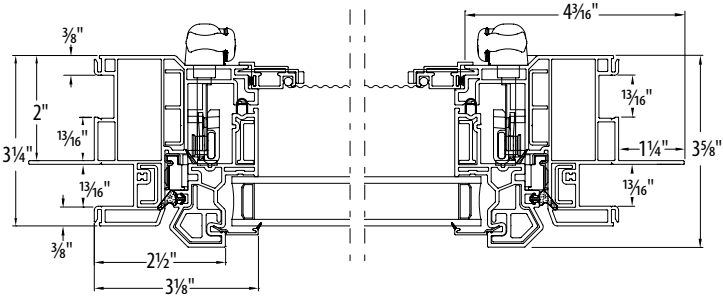

Callout sizes are expressed in inches and equal rough opening.
 Casement and awning windows have an interior frame depth of 2" and an exterior projection of 1-5/8" from the nail fin.
 When mulling a unit to a casement or awning, overall rough opening is not affected by the mullion.
 Meets DP50 rating. Specify DP50 when ordering.
 For the latest testing data, contact Customer Service or visit our website at www.Viwinco.com

Rough Opening	2-Lite Slider							
	24"	36"	48"	54"	60"	72"	84"	96"
Unit Size	23½"	35½"	47½"	53½"	59½"	71½"	83½"	95½"
Sash Opening	5⅝"	11⅜"	17⅜"	20⅜"	23⅜"	29⅜"	35⅜"	41⅜"
Visible Glass-Sash	7⅞"	13⅞"	19⅞"	22⅞"	25⅞"	31⅞"	37⅞"	43⅞"
24"	23½"	35½"	47½"	53½"	59½"	71½"	83½"	95½"
	2SL2424	2SL3624	2SL4824	2SL5424	2SL6024	2SL7224	2SL8424	2SL9624
36"	35½"	35½"	47½"	53½"	59½"	71½"	83½"	95½"
	2SL2436	2SL3636	2SL4836	2SL5436	2SL6036	2SL7236 ●	2SL8436 ●	2SL9636 ●
42"	41½"	35⅝"	47½"	53½"	59½"	71½"	83½"	95½"
	2SL2442	2SL3642	2SL4842	2SL5442	2SL6042	2SL7242 ●	2SL8442 ●	2SL9642 ●
48"	47½"	41⅝"	47½"	53½"	59½"	71½"	83½"	95½"
	2SL2448	2SL3648	2SL4848	2SL5448 ●	2SL6048 ●	2SL7248 ●	2SL8448 ●	2SL9648 ●
60"	59½"	53⅝"	47½"	53½"	59½"	71½"	83½"	95½"
	2SL2460	2SL3660	2SL4860	2SL5460 ●	2SL6060 ●	2SL7260 ●	2SL8460 ●	2SL9660 ●

2-Lite Slider Horizontal Detail

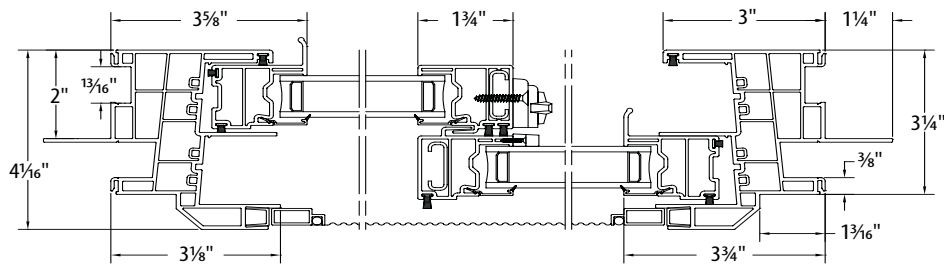

Rough Opening	3-Lite End-Vent Slider (XOX) [®]					
	72"	84"	96"	108"	120"	138"
Unit Size	71½"	83½"	95½"	107½"	119½"	137½"
Sash Opening	15⅜"	18⅜"	21⅜"	24⅜"	27⅜"	31⅜"
Total Visible Glass	60⅞"	72⅞"	84⅞"	96⅞"	108⅞"	126⅞"
36"	35½"	29⅜"	26½"			
48"	47½"	41⅜"	38½"			
60"	59½"	53⅜"	50½"			

3-Lite End-Vent Slider (XOX)[®] Horizontal Detail

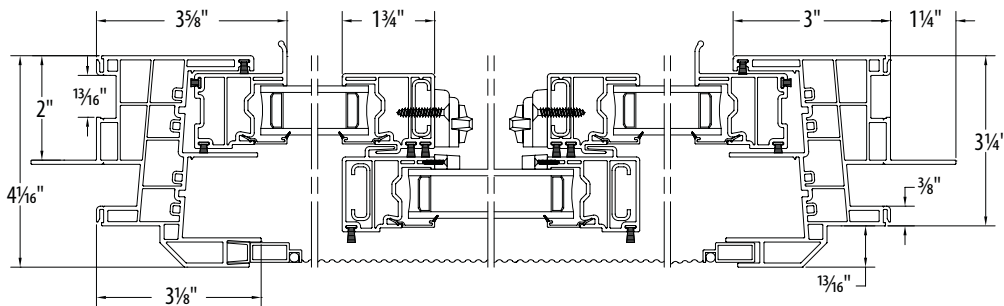

Callout sizes are expressed in inches (width x height) and equal rough opening.

Slider windows have an interior frame depth of 2"; exterior projection of the frame is 1-3/16" from the nail fin.

When mulling a unit to a slider overall rough opening is not affected by the mullion.

Half-screen is standard for 2-lite sliders and a screen for each operable flanker is standard for 3-lite end-vent sliders.

- Meets egress of:
Clear opening area ≥ 5.7 sq. ft.
Clear opening width ≥ 20"
Clear opening height ≥ 24"

● 3-lite end-vent sliders:

- Fixed center window is 50% of the total unit with operable sashes 25% each
- Equal-sash 3-lite end-vent slider is also available (XOX option only). Each sash is 33.3% of the total window unit
- All grid choices are available in the fixed center window

□ ONLY 2-Lite SLiders meet DP50 rating. Specify DP50 when ordering.

For the latest testing data, contact Customer Service or visit our website at www.Viwinco.com

Rough Opening	Double-Hung Bay Windows 10°, 30° and 45°						
	47-1/2" - 60"	61" - 72"	73" - 84"	85" - 96"	97" - 108"	109" - 120"	121" - 144"
32" - 40"							
41" - 50"							
51" - 60"							
61" - 70"							
71" - 80"							

Rough Opening	Casement Bay Windows 10°, 30° and 45°						
	47-1/2" - 60"	61" - 72"	73" - 84"	85" - 96"	97" - 108"	109" - 120"	121" - 144"
32" - 40"							
41" - 50"							
51" - 60"							
61" - 70"							
71" - 80"							

For Casement Bay Windows, each individual Casement unit cannot exceed 36"x72". Each individual Casement Picture unit cannot exceed 72"x72".

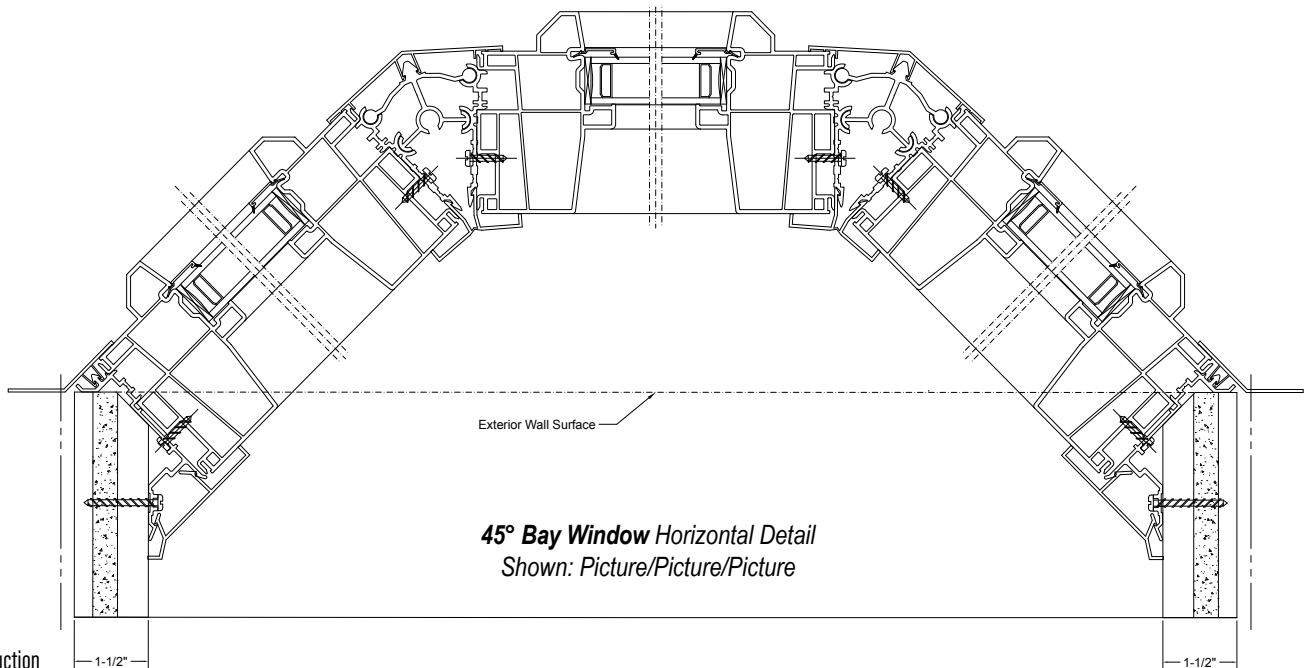

Rough Opening	Double-Hung 3-Lite Bow Windows		Double-Hung 4-Lite Bow Windows		
	47-1/2" - 72"	73" - 91-1/2"	73-1/4" - 95"	96" - 120"	121" - 144"
32" - 40"					
41" - 50"					
51" - 60"					
61" - 70"					
71" - 80"					

10° Bow Window Vertical Detail

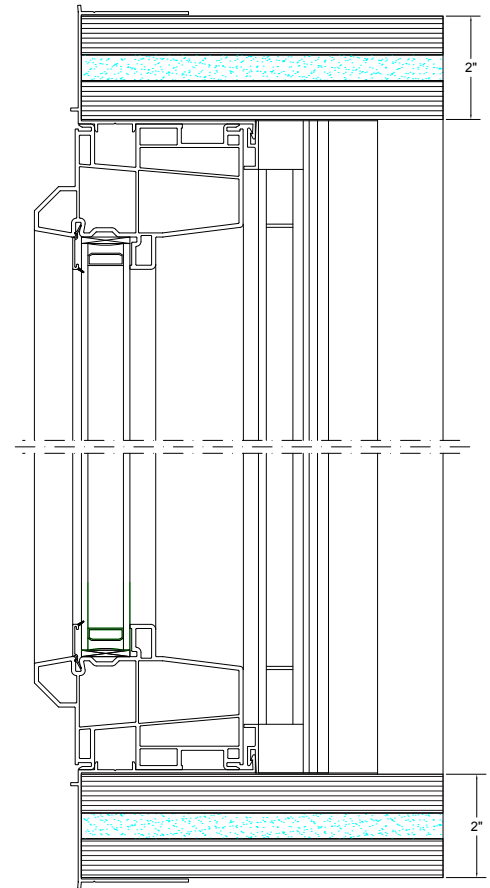

Rough Opening	Double-Hung 5-Lite Bow Windows		
	90-1/2" - 105"	106" - 120"	121" - 144"
32" - 40"			
41" - 50"			
51" - 60"			
61" - 70"			
71" - 80"			

Bays & Bows

- ▶ Design your own bay or bow unit with single-hung, double-hung, casement or picture styles. See individual size charts for dimensions, or order a custom size. Custom jamb depths and projections are available.
- ▶ 2" head and seat board are constructed of 1/2" foam insulation sandwiched between two 3/4" pieces of marine-grade plywood with birch veneer and a 10 mm vinyl exterior. Paintable or stainable (oak veneer headboard and seat board also available as an upgrade).

Meets DP50 rating. Specify DP50 when ordering.
 For the latest testing data, contact Customer Service or visit our website at www.Viwinco.com

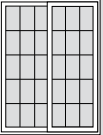
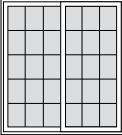
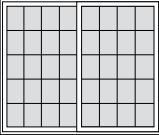
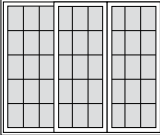
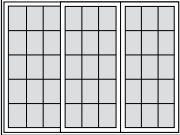
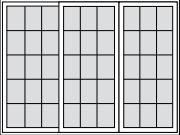
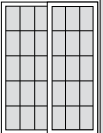
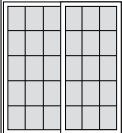
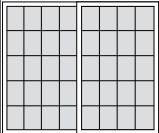
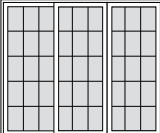
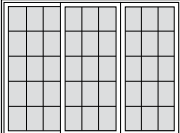
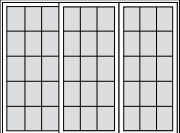
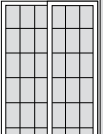
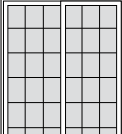
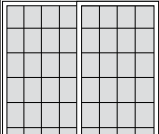
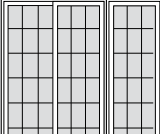
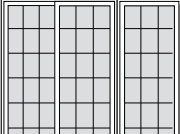
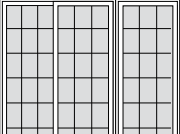
Rough Opening		Patio Door - 2-Panel (XO/OX) KD Assembly® Available			Rough Opening		Patio Door - 3-Panel (OXO) KD Assembly® Available			
		60"	72"	96"			90"	108"	144"	
Unit Size		59½"	71½"	95½"	Unit Size		89½"	107½"	143½"	
80"	79½"	 PD26080	 PD27280 ●	 PD29680	80"	79½"	 PD39080	 PD310880 ●	 PD314480	
	82"	 PD26082	 PD27282 ●	 PD29682		82"	81½"	 PD39082	 PD310882 ●	 PD314482
	96"	 PD26096	 PD27296	 PD29696		96"	95½"	 PD39096	 PD310896	 PD314496 ●

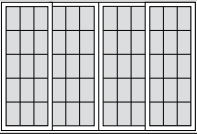
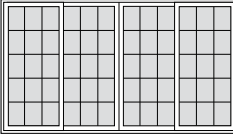
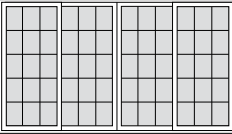
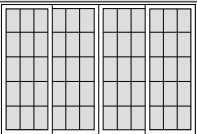
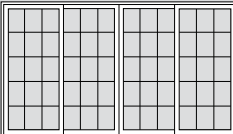
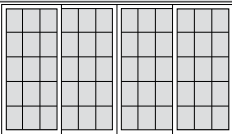
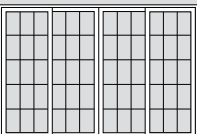
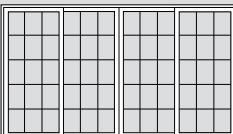
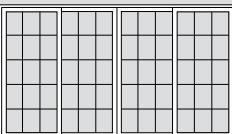
Rough Opening		Patio Door - 4-Panel (OXXO) KD Assembly® Available		
		118"	144"	192"
Unit Size		117½"	143½"	191½"
80"	79½"	 PD411880	 PD414480	 PD419280 ●
	82"	 PD411882	 PD414482 ●	 PD419282 ●
	96"	 PD411896	 PD414496 ●	 PD419296 ●

Patio Door Cross-Sectional Head and Sill Detail

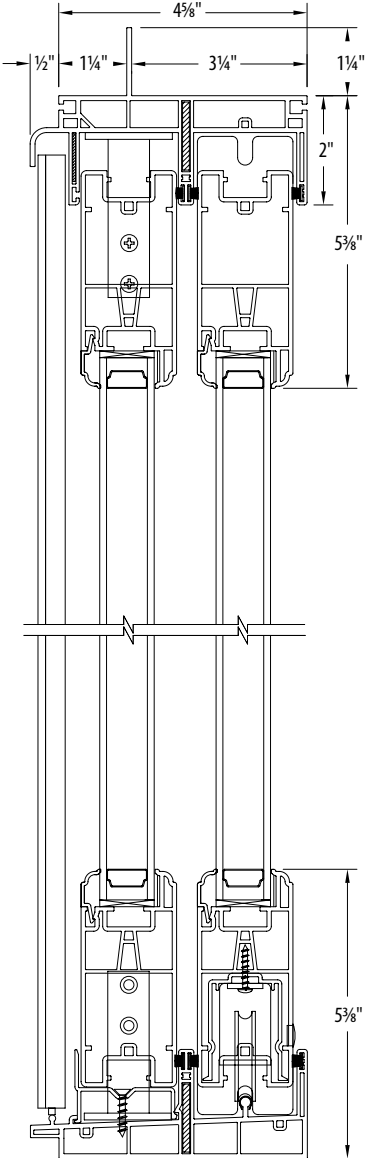

Patio Door Cross-Sectional Jamb Detail

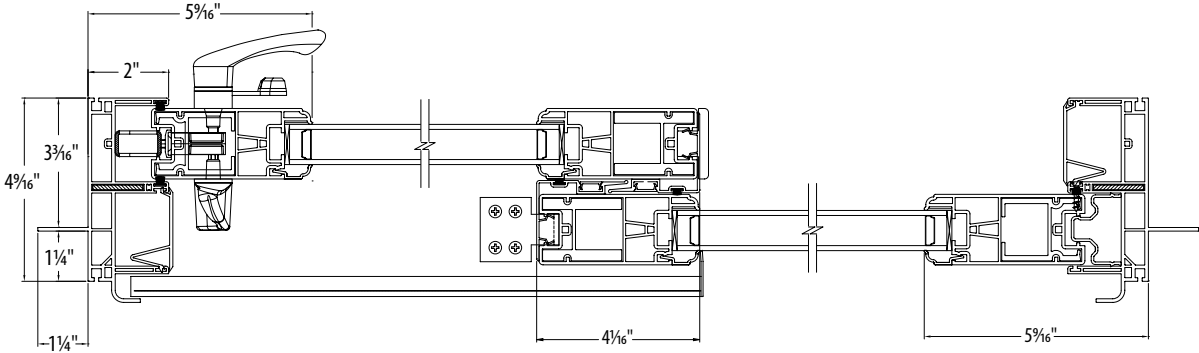

Callout sizes are expressed in inches and equal rough opening.

Patio doors have an interior frame depth of 3-3/8" and an exterior projection of 1-1/2" from the nail fin.

Patio doors are not field reversible.

Two-point lock with adjustable strikes on all patio doors.

- Available with blinds between the glass
- Stock and custom sized doors within shaded zones are KD assembly only
- Knock down assembly
- ☐ Meets DP50 rating. Specify DP50 when ordering.

For the latest testing data, contact Customer Service or visit our website at www.Viwinco.com

Rough Opening		Patio Door Transom		
		60"	72"	96"
Unit Size		59½"	71½"	95½"
16"	15½"	PDTSM6016	PDTSM7216	PDTSM9616 ②
	19½"	PDTSM6020	PDTSM7220	PDTSM9620 ②
24"	23½"	PDTSM6024 ②	PDTSM7224 ②	PDTSM9624 ②

Rough Opening		Patio Door Sidelite			
		32"	38"	42"	48"
Unit Size		31½"	37½"	41½"	47½"
80"	79½"	PDTSM3280 ②	PDTSM3880 ②	PDTSM4280 ②	PDTSM4880 ②
	81½"	PDTSM3282 ②	PDTSM3882 ②	PDTSM4282 ②	PDTSM4882 ②
96"	95½"	PDTSM3296 ②	PDTSM3896 ②	PDTSM4296 ②	PDTSM4896 ②

Patio Door Transom Cross-Sectional Jamb Detail

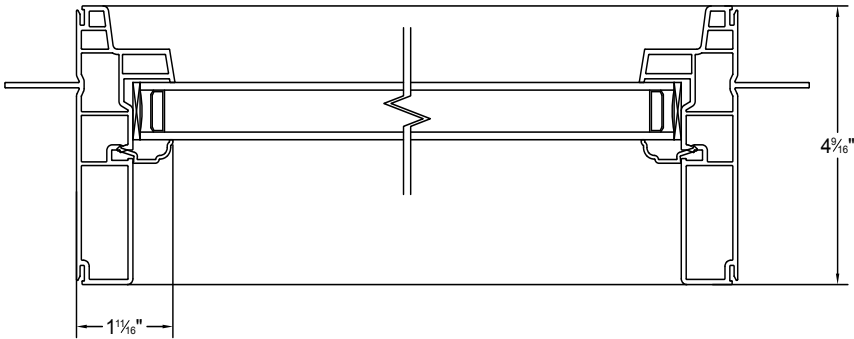

Rough Opening		Geometric shapes for patio doors—half-round		
		60"	72"	96"
Unit Size		59½"	71½"	95½"
30"	29½"	PDHR6030 ②		
	35½"		PDHR7236 ②	
48"	47½"			PDHR9648 ②

Rough Opening		Geometric shapes for patio doors—elliptical		
		60"	72"	96"
Unit Size		59½"	71½"	95½"
18"	17½"	PDEL6018		
	19½"		PDEL7220	PDEL9620 ②

Grid patterns for geometric shapes—half-round

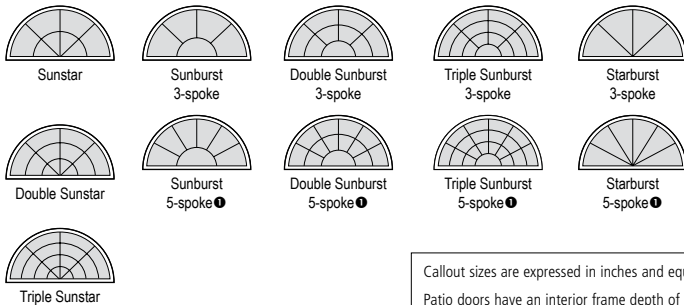

Grid patterns for geometric shapes—elliptical

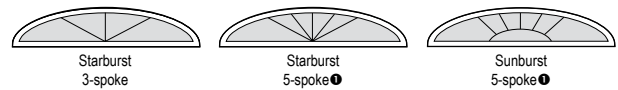

Callout sizes are expressed in inches and equal rough opening.

Patio doors have an interior frame depth of 3-3/8" and an exterior projection of 1-1/2" from the nail fin.

Transoms and sidelites have an interior frame depth of 3-3/8" and an exterior projection of 1-3/8" from the nail fin.

When mulling a transom or sidelite to a patio door, add 1" to the overall rough opening total unit dimension for each mullion.

Patio doors are not field reversible.

Two-point lock with adjustable strikes on all patio doors.

① 5-spoke starburst pattern: Minimum window size is 60" for either deluxe or flat grids.

② If a sidelite is mullied to a patio door, the unit will not meet DP50.

☐ Meets DP50 rating. Specify DP50 when ordering.

For the latest testing data, contact Customer Service or visit our website at www.viwinco.com

3.5" Flat Casing Picture Frame w/ Pocket Filler
Vertical Detail

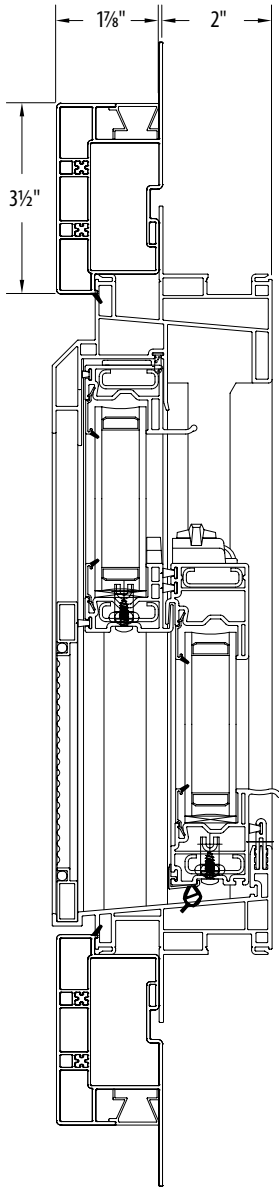

Brick Mold Casing w/ Bullnose Sill and Pocket Filler
Vertical Detail

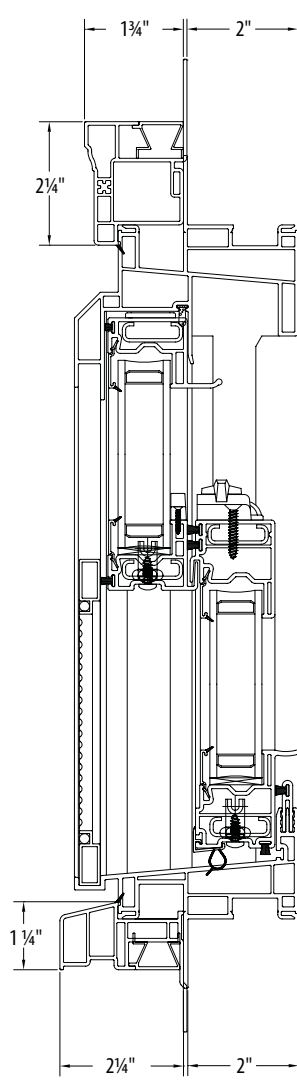

3.5" Flat Casing w/o Pocket Filler Horizontal Detail

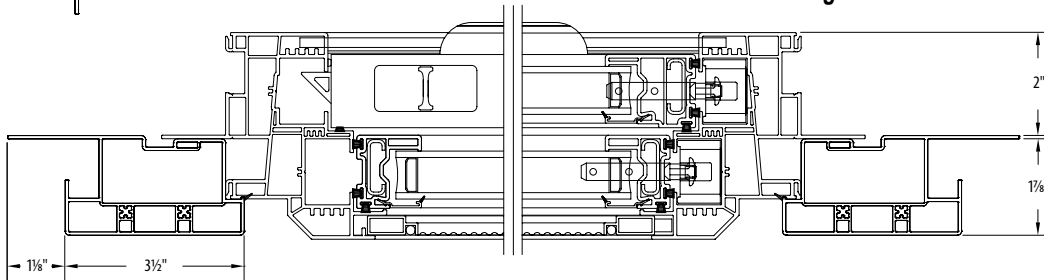

Brick Mold Casing w/o Pocket Filler Horizontal Detail

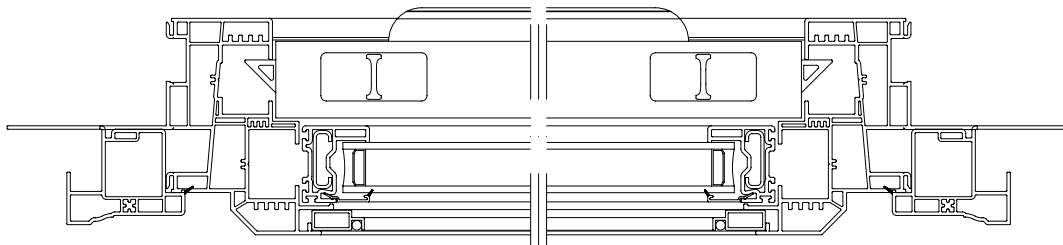



851 Hemlock Road

Morgantown, PA 19543

Visit us at www.Viwinco.com

4/2026