

OCEANVIEW

NEW CONSTRUCTION + REPLACEMENT WINDOWS

Window Sizes and Detail Drawings



IMPRESS THE WEATHER

Table of Contents

Window Sizes and Detail Drawings

Single-Hung	1-3
Double-Hung	4-6
Geometric Windows	7-8
Sliding Windows	9
Picture and Transom Windows	10
Casement Awning Windows	11-14
Patio Doors	15-17
Patio Doors Sidelite & Transom	18
Patio Doors Geometric Shapes	19
Casing & Brickmold	20

OceanView Single-Hung | Window Sizes and Detail Drawings

Rough Opening		Single-Hung								
		20"	24"	28"	32"	36"	40"	44"	48"	52"
Unit Size		19 1/2"	23 1/2"	27 1/2"	31 1/2"	35 1/2"	39 1/2"	43 1/2"	47 1/2"	51 1/2"
Sash Opening		13 7/16"	17 7/16"	21 7/16"	25 7/16"	29 7/16"	33 7/16"	37 7/16"	41 7/16"	47 5/16"
Visible Glass-Sash		11 13/16"	15 13/16"	19 13/16"	23 13/16"	27 13/16"	31 13/16"	35 13/16"	39 13/16"	44 3/4"
36"	35 1/2"									
	13 3/8"	OVSH2036	OVSH2436	OVSH2836	OVSH3236	OVSH3636	OVSH4036	OVSH4436	OVSH4836	OVSH5236
44"	43 1/2"									
	17 9/16"	OVSH2044	OVSH2444	OVSH2844	OVSH3244	OVSH3644	OVSH4044	OVSH4444	OVSH4844	OVSH5244
48"	47 1/2"									
	19 9/16"	OVSH2048	OVSH2448	OVSH2848	OVSH3248	OVSH3648	OVSH4048	OVSH4448	OVSH4848	OVSH5248
52"	51 1/2"									
	21 9/16"	OVSH2052	OVSH2452	OVSH2852	OVSH3252	OVSH3652	OVSH4052	OVSH4452	OVSH4852	OVSH5252
60"	59 1/2"									
	25 9/16"	OVSH2060	OVSH2460	OVSH2860	OVSH3260	OVSH3660	OVSH4060 ❶	OVSH4460 ❶	OVSH4860 ❶	OVSH5260 ❶
66"	65 1/2"									
	28 9/16"	OVSH2066	OVSH2466	OVSH2866	OVSH3266	OVSH3666 ❶	OVSH4066 ❶	OVSH4466 ❶	OVSH4866 ❶	OVSH5266 ❶
72"	71 1/2"									
	31 9/16"	OVSH2072	OVSH2472	OVSH2872	OVSH3272	OVSH3672 ❶	OVSH4072 ❶	OVSH4472 ❶	OVSH4872 ❶	OVSH5272 ❶
80"	79 1/2"									
	37 7/8"	OVSH2080	OVSH2480	OVSH2880	OVSH3280	OVSH3680 ❶	OVSH4080 ❶	OVSH4480 ❶	OVSH4880 ❶	OVSH5280 ❶

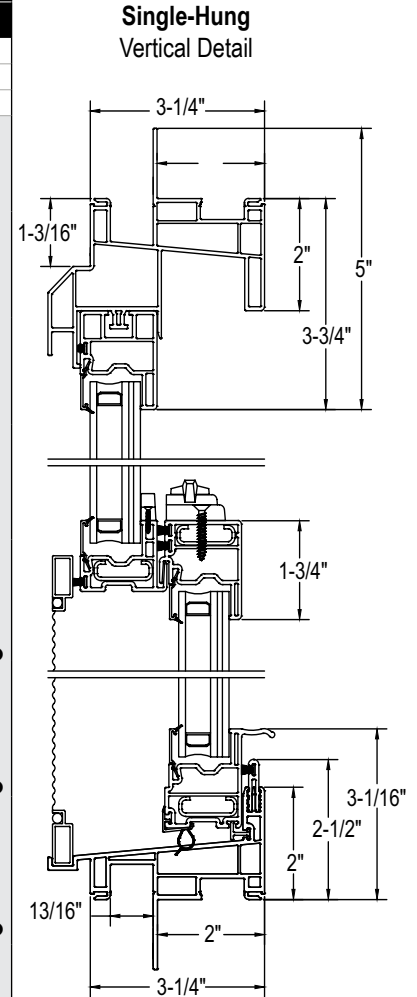

Callout sizes are expressed in inches and equal rough opening.

Single-hung windows have an interior frame depth of 2" and an exterior projection of 1-3/16" from the nail fin.

When mulling a unit to a single-hung, overall rough opening is not affected by the mullion.

Picture or transom windows have an interior frame depth of 2" and an exterior projection of 2" from the nail fin.

66" tall windows are the maximum size available as oriels. Oriels are windows having 60% to 40% sash height proportions with the larger sash on top. Reverse oriels have the smaller sash on top.

❶ Meets egress of:

- Clear openable area ≥ 5.7 sq. ft.
- Clear openable width ≥ 20"
- Clear openable height ≥ 24"

❷ 2U1R2C: Mullied two-unit (one row, two columns).

❸ 3U1R3C: Mullied three-unit (one row, three column).

☐ All sizes shown meet DP50 rating.

For the latest testing data, contact Customer Service or visit our website at www.Viwinco.com.

Rough Opening	Twin Single-Hung 2U1R2C [®]			Triple Single-Hung 3U1R3C [®]	
	56"	64"	72"	84"	96"
Unit Size	55 1/2"	63 1/2"	71 1/2"	83 1/2"	95 1/2"
Sash Opening	21 7/16"	25 7/16"	29 7/16"	21 3/16"	25 7/16"
Visible Glass-Sash	19 13/16"	23 13/16"	27 13/16"	19 13/16"	23 13/16"
36"	35 1/2" 13 9/16"	43 1/2" 17 9/16"	47 1/2" 19 9/16"	51 1/2" 21 9/16"	59 1/2" 25 9/16"
44"	43 1/2" 17 9/16"	47 1/2" 19 9/16"	51 1/2" 21 9/16"	59 1/2" 25 9/16"	65 1/2" 28 9/16"
48"	47 1/2" 19 9/16"	51 1/2" 21 9/16"	59 1/2" 25 9/16"	65 1/2" 28 9/16"	71 1/2" 31 9/16"
52"	51 1/2" 21 9/16"	59 1/2" 25 9/16"	65 1/2" 28 9/16"	71 1/2" 31 9/16"	79 1/2" 35 7/8"
60"	59 1/2" 25 9/16"	65 1/2" 28 9/16"	71 1/2" 31 9/16"	79 1/2" 35 7/8"	—
66"	65 1/2" 28 9/16"	71 1/2" 31 9/16"	79 1/2" 35 7/8"	—	—
72"	71 1/2" 31 9/16"	79 1/2" 35 7/8"	—	—	—
80"	79 1/2" 35 7/8"	—	—	—	—

Twin Single-Hung 2U1R2C[®] Horizontal Detail

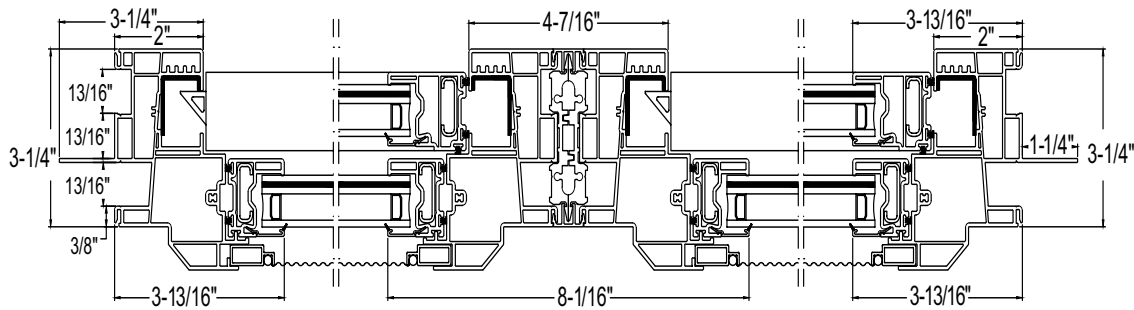

Triple Single-Hung 3U1R3C[®] Horizontal Detail

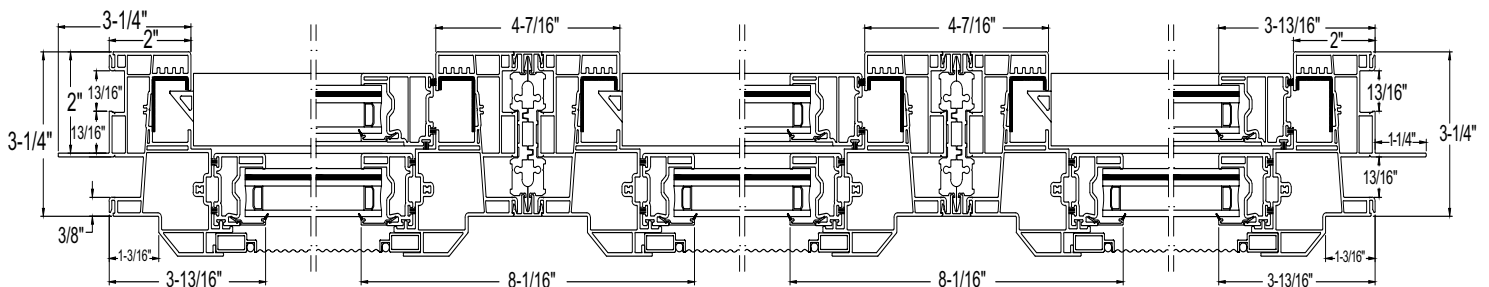

OceanView Single-Hung | Window Sizes and Detail Drawings

Rough Opening					Single-Hung with Transom 2U2R1C [®]							
					28"	32"	36"					
Unit Size					27 1/2"	31 1/2"	35 1/2"					
Sash Opening					21 7/16"	25 7/16"	29 7/16"					
Visible Glass-Upper Sash					19 13/16"	23 13/16"	27 13/16"					
Visible Glass-Sash					19 3/4"	23 3/4"	25 3/4"					
60"	59 1/2"	19 9/16"	19 7/8"	5 3/4"								
					OVSHSTM2860	OVSHSTM3260	OVSHSTM3660					
					66"	65 1/2"	22 9/16"	22 7/8"	5 3/4"			
										OVSHSTM2866	OVSHSTM3266	OVSHSTM3666
										72"	71 1/2"	25 9/16"
OVSHSTM2872	OVSHSTM3272	OVSHSTM3672										
80"	79 1/2"	26 9/16"	26 7/8"	17 3/4"								
					OVSHSTM2880	OVSHSTM3280	OVSHSTM3680					

Single-Hung with Transom 2U2R1C[®]
Vertical Detail

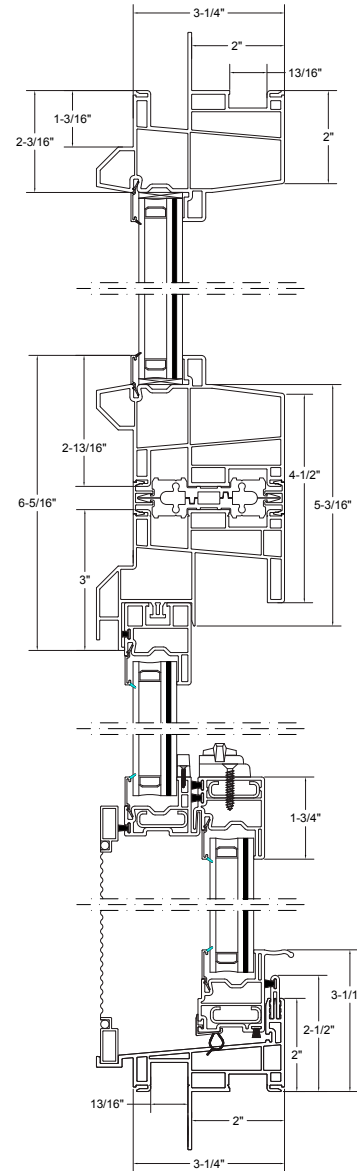

Rough Opening					Single-Hung/Picture/Single-Hung 3U1R3C [®]		
					80"	92"	104"
Unit Size					79 1/2"	91 1/2"	103 1/2"
SHPXSH Unit Configuration					20-40-20	24-44-24	28-48-28
Sash Opening					13 7/16"	17 7/16"	21 7/16"
Visible Glass-Sash					11 13/16"	15 13/16"	19 13/16"
Visible Glass-Fixed Center					33 3/4"	37 3/4"	41 3/4"
36"	35 1/2"	13 9/16"	13 7/8"	29 3/4"			
					OVSHPXSH8036	OVSHPXSH9236	OVSHPXSH10436
					48"	47 1/2"	19 9/16"
OVSHPXSH8048	OVSHPXSH9248	OVSHPXSH10448					
60"	59 1/2"	25 9/16"	25 7/8"	53 3/4"			
					OVSHPXSH8060	OVSHPXSH9260	OVSHPXSH10460

Single-Hung/Picture/Single-Hung 3U1R3C[®] Horizontal Detail

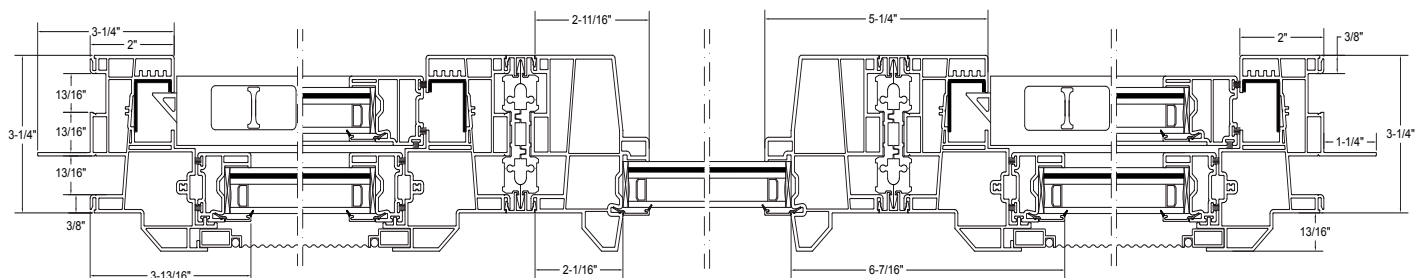

Rough Opening		Double-Hung							
		20"	24"	28"	32"	36"	40"	44"	48"
Unit Size		19 1/2"	23 1/2"	27 1/2"	31 1/2"	35 1/2"	39 1/2"	43 1/2"	47 1/2"
Sash Opening		13 3/16"	17 3/16"	21 3/16"	25 3/16"	29 3/16"	33 3/16"	37 3/16"	41 3/16"
Visible Glass-Upper Sash		11 3/4"	15 3/4"	19 3/4"	23 3/4"	27 3/4"	31 3/4"	35 3/4"	39 3/4"
Visible Glass-Lower Sash		11 3/4"	15 3/4"	19 3/4"	23 3/4"	27 3/4"	31 3/4"	35 3/4"	39 3/4"
36"	35 1/2"								
	13 1/4"	OVDH2036	OVDH2436	OVDH2836	OVDH3236	OVDH3636	OVDH4036	OVDH4436	OVDH4836
44"	43 1/2"								
	17 1/8"	OVDH2044	OVDH2444	OVDH2844	OVDH3244	OVDH3644	OVDH4044	OVDH4444	OVDH4844
48"	47 1/2"								
	19 1/8"	OVDH2048	OVDH2448	OVDH2848	OVDH3248	OVDH3648	OVDH4048	OVDH4448	OVDH4848
52"	51 1/2"								
	21 1/8"	OVDH2052	OVDH2452	OVDH2852	OVDH3252	OVDH3652	OVDH4052	OVDH4452	OVDH4852
60"	59 1/2"								
	25 1/8"	OVDH2060	OVDH2460	OVDH2860	OVDH3260	OVDH3660	OVDH4060 ^①	OVDH4460 ^①	OVDH4860 ^①
62"	61 1/2"								
	26 1/8"	OVDH2062	OVDH2462	OVDH2862	OVDH3262	OVDH3662	OVDH4062 ^①	OVDH4462 ^①	OVDH4862 ^①
66"	65 1/2"								
	28 1/8"	OVDH2066	OVDH2466	OVDH2866	OVDH3266	OVDH3666 ^①	OVDH4066 ^①	OVDH4466 ^①	OVDH4866 ^①
72"	71 1/2"								
	31 1/8"	OVDH2072	OVDH2472	OVDH2872	OVDH3272	OVDH3672 ^①	OVDH4072 ^①	OVDH4472 ^①	OVDH4872 ^①
80"	79 1/2"								
	35 1/8"	OVDH2080	OVDH2480	OVDH2880	OVDH3280	OVDH3680 ^①	OVDH4080 ^①	OVDH4480 ^①	OVDH4880 ^①

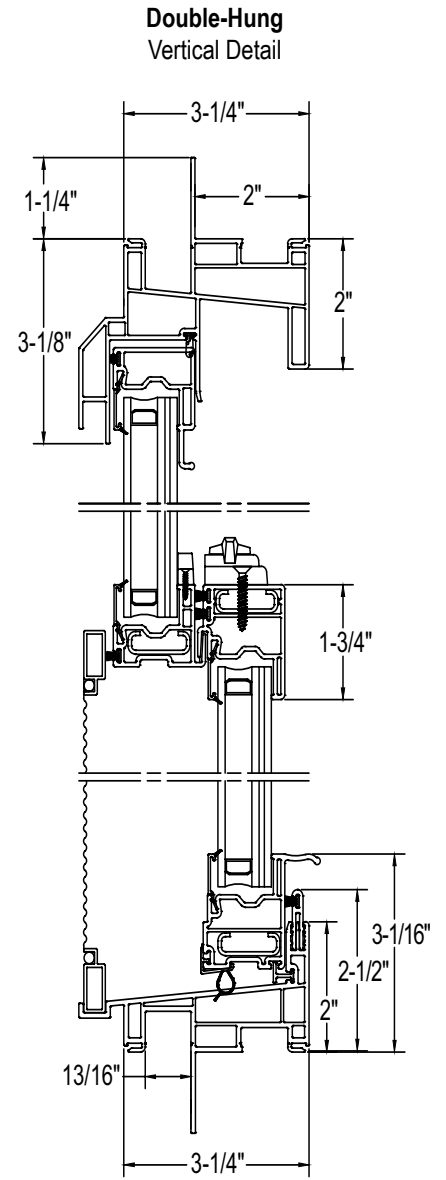

Callout sizes are expressed in inches and equal rough opening.

Single- and double-hung windows have an interior frame depth of 2" and an exterior projection of 1-3/16" from the nail fin.

66" Tall windows are the maximum size available as oriels. Oriels are windows having 60% to 40% sash height proportions with the larger sash on top. Reverse oriels have the smaller sash on top.

- ① Meets egress of:
Clear openable area ≥ 5.7 sq. ft.
Clear openable width ≥ 20"
Clear openable height ≥ 24"

② 2U2R1C: Mullied two-unit (two rows, one column).

③ 3U1R3C: Mullied three-unit (one row, three column).

When mulling a unit to a picture or transom, overall rough opening is not affected by the mullion.

☐ All sizes shown meet DP50 rating.

For the latest testing data, contact Customer Service or visit our website at www.Viwinco.com.

OceanView Double-Hung | Window Sizes and Detail Drawings

Rough Opening	Twin Double-Hung 2U1R2C [®]				Triple Double-Hung 3U1R3C [®]			
	56"	64"	72"	96"	84"	96"	108"	
Unit Size	55 1/2"	63 1/2"	71 1/2"	95 1/2"	83 1/2"	95 1/2"	107 1/2"	
Sash Opening	21 3/16"	25 3/16"	29 3/16"	41 3/16"	21 3/16"	25 3/16"	29 3/16"	
Visible Glass-Upper Sash	19 3/4"	23 3/4"	27 3/4"	39 3/4"	19 3/4"	23 3/4"	27 3/4"	
Visible Glass-Lower Sash	19 3/4"	23 3/4"	27 3/4"	39 3/4"	19 3/4"	23 3/4"	27 3/4"	
36"	35 1/2" 13 1/4" 13 1/8"	OVDHDH5636	OVDHDH6436	OVDHDH7236	OVDHDH9636	OVDHDHDH8436	OVDHDHDH9636	OVDHDHDH10836
44"	43 1/2" 17 1/4" 17 1/8"	OVDHDH5644	OVDHDH6444	OVDHDH7244	OVDHDH9644	OVDHDHDH8444	OVDHDHDH9644	OVDHDHDH10844
48"	47 1/2" 19 1/4" 19 1/8"	OVDHDH5648	OVDHDH6448	OVDHDH7248	OVDHDH9648	OVDHDHDH8448	OVDHDHDH9648	OVDHDHDH10848
52"	51 1/2" 21 1/4" 21 1/8"	OVDHDH5652	OVDHDH6452	OVDHDH7252	OVDHDH9652	OVDHDHDH8452	OVDHDHDH9652	OVDHDHDH10852
60"	59 1/2" 25 1/4" 25 1/8"	OVDHDH5660	OVDHDH6460	OVDHDH7260	OVDHDH9660	OVDHDHDH8460	OVDHDHDH9660	OVDHDHDH10860
62"	61 1/2" 26 1/4" 26 1/8"	OVDHDH5662	OVDHDH6462	OVDHDH7262	OVDHDH9662	OVDHDHDH8462	OVDHDHDH9662	OVDHDHDH10862
66"	65 1/2" 28 1/4" 28 1/8"	OVDHDH5666	OVDHDH6466	OVDHDH7266	OVDHDH9666	OVDHDHDH8466	OVDHDHDH9666	OVDHDHDH10866
72"	71 1/2" 31 1/4" 31 1/8"	OVDHDH5672	OVDHDH6472	OVDHDH7272 ●	OVDHDH9672 ●	OVDHDHDH8472	OVDHDHDH9672	OVDHDHDH10872
80"	79 1/2" 32 1/4" 35 1/8"	OVDHDH5680	OVDHDH6480	OVDHDH7280 ●	OVDHDH9680 ●	—	—	—

Twin Double-Hung 2U1R2C[®] Horizontal Detail

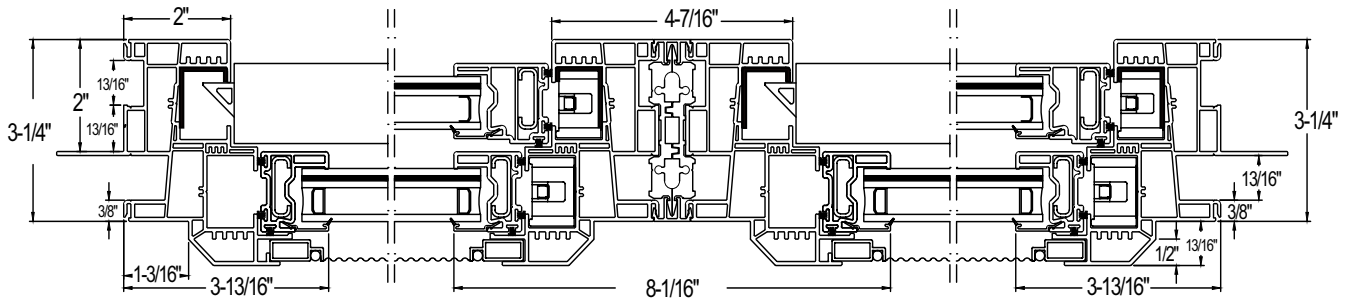

Triple Double-Hung 3U1R3C[®] Horizontal Detail

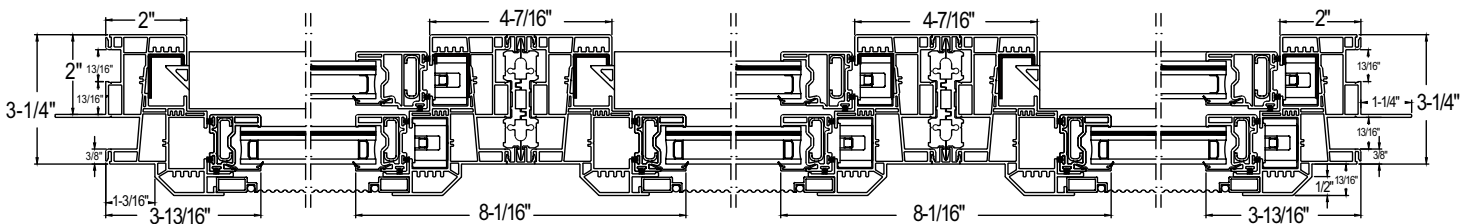

Rough Opening		Double-Hung with Transom 2U2R1C [®]		
		28"	32"	36"
Unit Size		27 1/2"	31 1/2"	35 1/2"
Sash Opening		21 7/16"	25 7/16"	29 7/16"
Visible Glass-Upper Sash		19 13/16"	23 13/16"	27 13/16"
Visible Glass-Sash		19 3/4"	23 3/4"	25 3/4"
60"	59 1/2"			
	19 9/16"	OVDHTSM2860	OVDHTSM3260	OVDHTSMV3660
66"	65 1/2"			
	22 9/16"	OVDHTSM2866	OVDHTSM3266	OVDHTSM3666
72"	71 1/2"			
	25 9/16"	OVDHTSM2872	OVDHTSM3272	OVDHTSM3672
80"	79 1/2"			
	26 7/8"	OVDHTSM2880	OVDHTSM3280	OVDHTSM3680

Rough Opening		Double-Hung /Picture/Double-Hung 3U1R3C [®]			
		80"	92"	104"	124"
Unit Size		79 1/2"	91 1/2"	103 1/2"	123 1/2"
ODHPXDH Unit Configuration		20-40-20	24-44-24	28-48-28	32-60-32
Sash Opening		13 3/16"	17 3/16"	21 3/16"	25 3/16"
Visible Glass-Upper Sash		11 3/4"	15 3/4"	19 3/4"	23 3/4"
Visible Glass-Upper Center		33 3/4"	37 3/4"	41 3/4"	53 3/4"
Visible Glass-Fixed Lower		11 3/4"	15 3/4"	19 3/4"	23 3/4"
36"	35 1/2"				
	13 9/16"	OVDHPXDH8036	OVDHPXDH9236	OVDHPXDH10436	OVDHPXDH12436
48"	47 1/2"				
	19 9/16"	OVDHPXDH8048	OVDHPXDH9248	OVDHPXDH10448	OVDHPXDH12448
60"	59 1/2"				
	25 9/16"	OVDHPXDH8060	OVDHPXDH9260	OVDHPXDH10460	OVDHPXDH12460

Double-Hung with Transom 2U2R1C[®] Vertical Detail

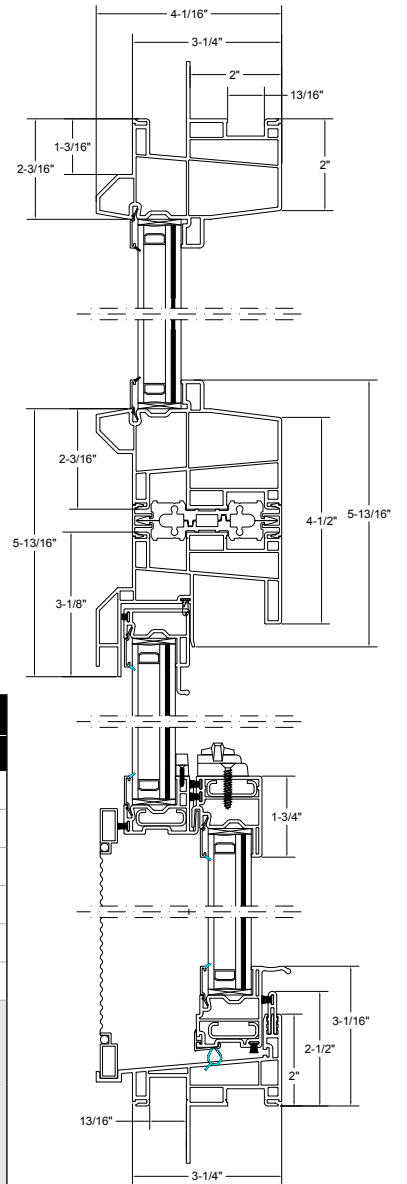

Double-Hung/ Picture/Double-Hung 3U1R3C[®] Horizontal Detail

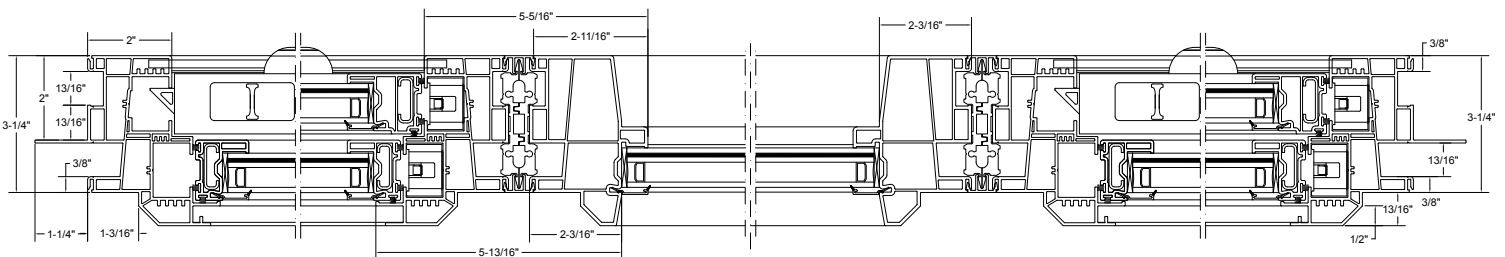

Callout sizes are expressed in inches and equal rough opening. Double-hung windows have an interior frame depth of 2"; exterior projection of the frame is 1-3/16" from the nail fin. When mulling a unit to a double-hung, overall rough opening is not affected by the mullion. 66" Tall windows are the maximum size available as oriels.

Oriels are windows having 60% to 40% sash height proportions with the larger sash on top. In reverse oriels, the smaller sash is on top.

- Meets egress of:
 - Clear opening area ≥ 5.7 sq. ft.
 - Clear opening width ≥ 20"
 - Clear opening height ≥ 24"
- 2U1R2C: Mullied two-unit (one row, two columns).

- 3U1R3C: Mullied three-unit (one row, three column).
- 2U2R1C: Mullied three-unit (two rows, one column).
- All sizes shown meet DP50 rating.

For the latest testing data, contact Customer Service or visit our website at www.viwinco.com.

OceanView Geometrics | Window Sizes and Detail Drawings

Extended Arch and Eyebrow									
Chord Height	4 3/8"	5 1/8"	5 7/8"	6 5/8"	7 7/16"	8 1/8"	9"	11 1/4"	13 1/2"
Radius	18"	21"	24"	27"	30"	32"	36"	45"	54"
Rough Opening	24"	28"	32"	36"	40"	44"	48"	60"	72"

Unit Size

Series

Shoulder Height (NET)

Series	Shoulder Height (NET)	Extended Arch and Eyebrow								
		Extended Arch and Eyebrow								
A	7 1/8"	Eyebrow								
B	19 1/8"	Extended Arch								
C	31 1/8"	Extended Arch								
D	39 1/8"	Extended Arch								
E	43 1/8"	Extended Arch								
F	47 1/8"	Extended Arch								
G	55 1/8"	Extended Arch								
H	61 1/8"	Extended Arch								
I	67 1/8"	Extended Arch								

Grid patterns and styles

Series A: Extended arch

Colonial pattern.
Available in deluxe or flat grids between the glass.

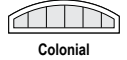

Colonial

Starburst pattern
Available in deluxe or flat grids between the glass.



Starburst

Maximum number of spokes: 5
Minimum width for 5 spokes: 60"

Series B to I: Extended arch

Colonial pattern
Available in deluxe or flat grids between the glass.

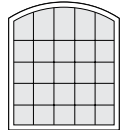

Colonial



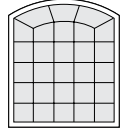











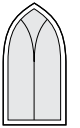
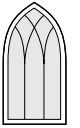
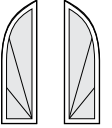
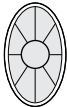
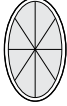
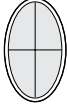
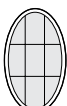

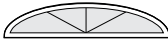











Cathedral pattern
Available in deluxe or flat grids between the glass.

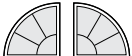

Cathedral

Rough Opening Width	Rough Opening Height								
	24"	28"	32"	36"	40"	44"	48"	60"	72"
Series A	12"	12 3/4"	13 1/2"	14 1/4"	15 1/8"	15 3/4"	16 5/8"	18 7/8"	13 1/8"
Series B	24"	24 3/4"	25 1/2"	26 1/4"	27 3/8"	27 3/4"	28 5/8"	30 7/8"	33 7/8"
Series C	36"	36 3/4"	37 1/2"	38 1/4"	39 3/8"	39 3/4"	40 5/8"	42 7/8"	45 1/8"
Series D	44"	44 3/4"	45 1/2"	46 1/4"	47 3/8"	47 3/4"	48 5/8"	50 7/8"	53 1/8"
Series E	48"	48 3/4"	49 1/2"	50 1/4"	51 3/8"	51 3/4"	52 5/8"	54 7/8"	57 1/8"
Series F	52"	52 3/4"	53 1/2"	54 1/4"	55 3/8"	55 3/4"	56 5/8"	58 7/8"	61 1/8"
Series G	60"	60 3/4"	61 1/2"	62 1/4"	63 3/8"	63 3/4"	64 5/8"	66 7/8"	-
Series H	66"	66 3/4"	67 1/2"	68 1/4"	69 3/8"	69 3/4"	70 5/8"	72 7/8"	-
Series I	72"	72 3/4"	73 1/2"	74 1/4"	75 3/8"	75 3/4"	76 5/8"	-	-

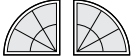
Rough opening height above equals shoulder height plus chord height plus 1/2".

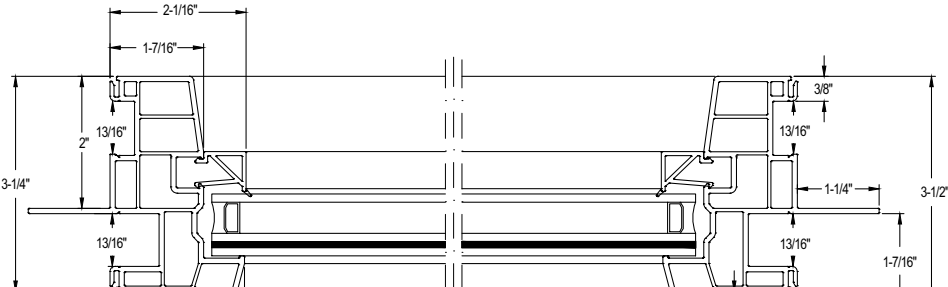
Circle	Gothic/ Half-Gothic	Oval/ Half-Oval	Elliptical	Octagon	Half-Round	Quarter-Round [®]
 <p>Sunburst</p>  <p>Starburst[Ⓢ]</p>  <p>Colonial Four-Lite</p>  <p>Colonial Nine-Lite</p> <p>Size Unit Dimensions OV-CIRCLE2424 23½" x 23½" OV-CIRCLE3030 29½" x 29½" OV-CIRCLE3636 35½" x 35½"</p>	 <p>One-Stem Tracery[Ⓢ]</p>  <p>Two-Stem Tracery[Ⓢ]</p> <p>Size Unit Dimensions OV-GOTH1836 17½" x 35½" OV-GOTH2040 19½" x 39½" OV-GOTH2244 21½" x 43½" OV-GOTH2448 23½" x 47½" OV-GOTH2856 27½" x 55½" OV-GOTH3060 29½" x 59½" OV-GOTH3672 35½" x 71½"</p> <p>Half-Gothic</p>  <p>Starburst[Ⓢ]</p> <p>Size (LEFT) Unit Dimensions OV-HGOTHL1854 17½" x 53½" OV-HGOTHL2260 21½" x 59½" OV-HGOTHL2666 25½" x 65½" OV-HGOTHL2872 27½" x 71½"</p> <p>Size (RIGHT) Unit Dimensions OV-HGOTHR1854 17½" x 53½" OV-HGOTHR2260 21½" x 59½" OV-HGOTHR2666 25½" x 65½" OV-HGOTHR2872 27½" x 71½"</p>	 <p>Sunburst</p>  <p>Starburst[Ⓢ]</p>  <p>Colonial Four-Lite</p>  <p>Colonial Nine-Lite</p> <p>Size Unit Dimensions OV-OVAL2436 23½" x 35½" OV-OVAL3656 35½" x 55½"</p> <p>Half-Oval</p>  <p>Sunburst</p>  <p>Starburst</p> <p>Size Unit Dimensions OV-HOVAL2418 23½" x 17½" OV-HOVAL3628 35½" x 27½"</p>	 <p>Starburst 3-Spoke</p>  <p>Sunstar 5-Spoke[Ⓢ]</p>  <p>Sunburst 5-Spoke[Ⓢ]</p> <p>Size Unit Dimensions OV-ELLIP6018 59½" x 17½" OV-ELLIP7220 71½" x 19½"</p> <p>For standard and custom orders, the maximum number of spokes is 5.</p>	 <p>Sunburst</p>  <p>Colonial Four-Lite</p>  <p>Colonial Nine-Lite</p> <p>Size Unit Dimensions OV-OCTA2424 23½" x 23½" OV-OCTA3232 31½" x 31½" OV-OCTA3636 35½" x 35½"</p>	 <p>Sunburst[Ⓢ]</p>  <p>Double-Sunburst[Ⓢ]</p>  <p>Triple-Sunburst[Ⓢ]</p>  <p>5-Spoke Sunburst[Ⓢ]</p>  <p>5-Spoke Double-Sunburst[Ⓢ]</p>  <p>5-Spoke Triple-Sunburst[Ⓢ]</p>  <p>Starburst</p>  <p>5-Spoke Starburst[Ⓢ]</p>  <p>Sunstar[Ⓢ]</p>  <p>Double-Sunstar[Ⓢ]</p>  <p>5-Spoke Triple-Sunstar[Ⓢ]</p> <p>Size Unit Dimensions OV-HRND2412 23½" x 11½" OV-HRND2814 27½" x 13½" OV-HRND3015 29½" x 14½" OV-HRND3216 31½" x 15½" OV-HRND3618 35½" x 17½" OV-HRND4020 39½" x 19½" OV-HRND4422 43½" x 21½" OV-HRND4824 47½" x 23½" OV-HRND5628 55½" x 27½" OV-HRND6030 59½" x 29½" OV-HRND6432 63½" x 31½" OV-HRND7236 71½" x 35½"</p> <p>For standard and custom orders, the maximum number of spokes is 5.</p>	 <p>2-Spoke Sunburst</p>  <p>2-Spoke Double-Sunburst[Ⓢ]</p>  <p>2-Spoke Starburst</p>  <p>1-Spoke Sunstar</p>  <p>2-Spoke Sunstar</p>  <p>1-Spoke Double-Sunstar[Ⓢ]</p>  <p>2-Spoke Double-Sunstar[Ⓢ]</p> <p>Size (LEFT) Unit Dimensions OV-QTRNDL2020 19½" x 19½" OV-QTRNDL2424 23½" x 23½" OV-QTRNDL2828 27½" x 27½" OV-QTRNDL3030 29½" x 29½" OV-QTRNDL3232 31½" x 31½" OV-QTRNDL3636 35½" x 35½"</p> <p>(left as viewed from outside)</p> <p>Size (RIGHT) Unit Dimensions OV-QTRNDR2020 19½" x 19½" OV-QTRNDR2424 23½" x 23½" OV-QTRNDR2828 27½" x 27½" OV-QTRNDR3030 29½" x 29½" OV-QTRNDR3232 31½" x 31½" OV-QTRNDR3636 35½" x 35½"</p> <p>(right as viewed from outside)</p>
<p>Custom Shapes</p> <p>Traditional rectangular, trapezoid, parallelogram, and other shapes utilizing fixed frames are available</p> <p>Geometric Windows, Extended Arch and Eyebrow. Horizontal Detail</p>  <p>Fixed extended arch and eyebrow windows have an interior frame depth of 2" and an exterior projection from the nail fin of 1-3/4".</p> <p>Callout sizes are expressed in inches (width) and equal rough opening.</p> <p>Geometric windows have an interior frame depth of 2"; exterior projection of the frame is 1-3/16" from the nail fin.</p> <p>Callout sizes are expressed in inches (width x height) and equal rough opening.</p> <p>Unless otherwise noted, patterns are available in deluxe or flat grids between the glass.</p> <p>Note: When geometric and picture windows are milled together, sightlines will not be even.</p> <ul style="list-style-type: none"> Specify left-hand or right-hand as viewed from the exterior. Available with flat grids between the glass only. Starburst, Sunburst, and Sunstar (5-spoke) patterns: minimum window size is 60" for either deluxe or flat grids. Double-Sunburst and Double-Sunstar patterns: minimum window size is 48" for either deluxe or flat grids. Sunstar and Sunburst (3-spoke) patterns: minimum window size is 28" for deluxe grids. Triple-Sunstar and Triple-Sunburst patterns: minimum window size is 72" for either deluxe or flat grids. All sizes shown meet DP50 rating. <p>For the latest testing data, contact Customer Service or visit our website at www.Viwinco.com.</p>						

OceanView Sliding Windows | Window Sizes and Detail Drawings

Rough Opening	2-Lite Slider										
	24"	36"	48"	54"	60"	72"	84"	96"			
Unit Size	23 1/2"	35 1/2"	47 1/2"	53 1/2"	59 1/2"	71 1/2"	83 1/2"	95 1/2"			
Sash Opening	5 3/16"	11 3/16"	17 3/16"	20 3/16"	23 3/16"	29 3/16"	35 3/16"	41 3/16"			
Visible Glass-Sash	7 1/8"	13 1/8"	19 1/8"	22 1/8"	25 1/8"	31 1/8"	37 1/8"	43 1/8"			
24"	23 1/2"	17 3/16"	14 3/4"	OV2SL2424	OV2SL3624	OV2SL4824	OV2SL5424	OV2SL6024	OV2SL7224	OV2SL8424	OV2SL9624
	35 1/2"	29 3/16"	26 3/4"	OV2SL2436	OV2SL3636	OV2SL4836	OV2SL5436	OV2SL6036	OV2SL7236	OV2SL8436	OV2SL9636
36"	41 1/2"	35 3/16"	32 3/4"	OV2SL2442	OV2SL3642	OV2SL4842	OV2SL5442	OV2SL6042	OV2SL7242	OV2SL8442	OV2SL9642
	47 1/2"	41 3/16"	38 3/4"	OV2SL2448	OV2SL3648	OV2SL4848	OV2SL5448	OV2SL6048	OV2SL7248	OV2SL8448	OV2SL9648
48"	59 1/2"	53 3/16"	50 3/4"	OV2SL2460	OV2SL3660	OV2SL4860	OV2SL5460	OV2SL6060	OV2SL7260	—	—
	63 1/2"	57 3/16"	54 3/4"	OV2SL2464	OV2SL3664	OV2SL4864	OV2SL5464	OV2SL6064	OV2SL7264	—	—

Rough Opening	3-Lite End-Vent Slider (XOX) [®]							
	72"	84"	96"	108"	120"			
Unit Size	71 1/2"	83 1/2"	95 1/2"	107 1/2"	119 1/2"			
Sash Opening	15 3/8"	18 3/8"	21 3/8"	24 3/8"	27 3/8"			
Total Visible Glass	60 1/16"	72 1/16"	84 1/16"	96 1/16"	108 1/16"			
36"	35 1/2"	29 3/16"	26 1/2"	3SL7236	3SL8436	3SL9636	3SL10836	3SL12036
	47 1/2"	41 3/16"	38 1/2"	3SL7248	3SL8448	3SL9648	3SL10848	3SL12048
48"	59 1/2"	53 3/16"	50 1/2"	3SL7260	3SL8460	3SL9660	3SL10860	3SL12060
	63 1/2"	57 3/16"	54 3/4"	3SL7264	3SL8464	3SL9664	3SL10864	3SL12064

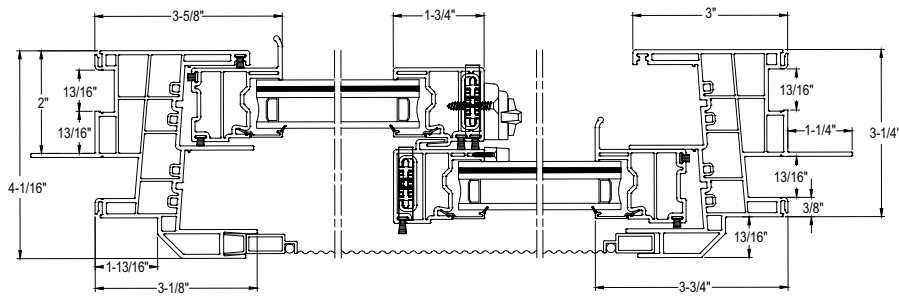

2-Lite Slider
Horizontal Detail

3-Lite End-Vent Slider (XOX)[®]
Horizontal Detail

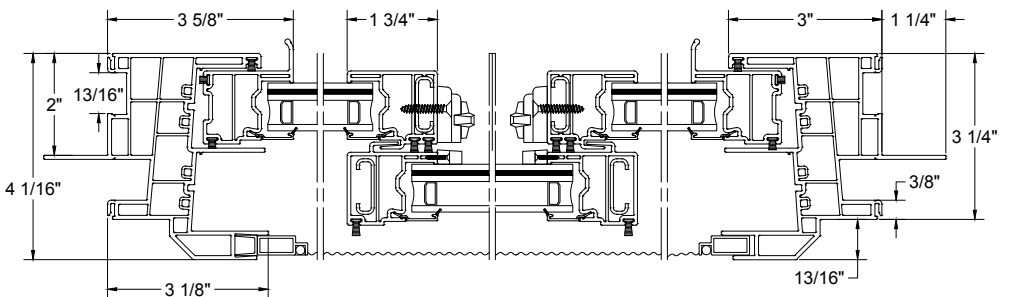

OceanView Casement | Window Sizes and Detail Drawings

Rough Opening	Casement						Twin Casement				
	18"	20"	24"	28"	30"	36"	36"	40"	48"	56"	72"
Unit Size	17 1/2"	19 1/2"	23 1/2"	27 1/2"	29 1/2"	35 1/2"	35 1/2"	39 1/2"	47 1/2"	55 1/2"	71 1/2"
Sash Opening	4 7/8"	6 7/8"	10 7/8"	14 7/8"	16 7/8"	22 7/8"	4 7/8"	6 7/8"	10 7/8"	14 7/8"	22 7/8"
Visible Glass-Sash	11 1/4"	13 1/4"	17 1/4"	21 1/4"	23 1/4"	29 1/4"	11 1/4"	13 1/4"	17 1/4"	21 1/4"	29 1/4"
24"	23 1/2" 17 1/4" 17 1/4"										
36"	35 1/2" 29 1/4" 29 1/4"										
42"	41 1/2" 35 1/4" 35 1/4"										
48"	47 1/2" 41 1/4" 41 1/4"										
52"	51 1/2" 45 1/4" 45 1/4"										
60"	59 1/2" 53 9/16" 53 1/4"										
66"	65 1/2" 58 1/4" 58 1/4"										
72"	71 1/2" 65 1/4" 65 1/4"										

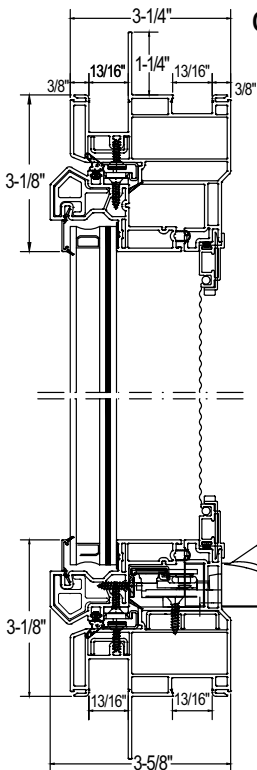

Casement Cross-Sectional Head & Sill Detail

Twin Casement Cross-Sectional Jamb Detail with Integral Mullion

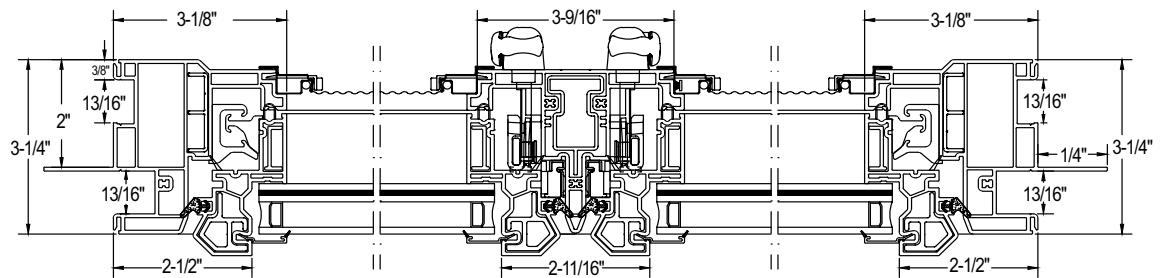

Rough Opening	Quad Casement				Casement/Picture/Casement				
	72"	80"	96"	112"	54"	60"	72"	84"	108"
Unit Size	71 1/2"	79 1/2"	95 1/2"	111 1/2"	53 1/2"	59 1/2"	71 1/2"	83 1/2"	107 1/2"
Sash Opening	4 7/8"	6 7/8"	10 7/8"	14 7/8"	4 7/8"	6 7/8"	10 7/8"	14 7/8"	22 7/8"
Visible Glass-Sash	11 1/4"	13 1/4"	17 1/4"	21 1/4"	11 1/4"	13 1/4"	17 1/4"	21 1/4"	29 1/4"
36"	35 1/2"	29 1/4"	29 1/4"						
	OVWW47236	OVWW48036	OVWW49636	OVWW411236	OVWW35436	OVWW36036	OVWW37236	OVWW38436	OVWW310836
42"	41 1/2"	35 1/4"	35 1/4"						
	OVWW47242	OVWW48042	OVWW49642	OVWW411242	OVWW35442	OVWW36042	OVWW37242	OVWW38442	OVWW310842
48"	47 1/2"	41 1/4"	41 1/4"						
	OVWW47248	OVWW48048	OVWW49648	OVWW411248	OVWW35448	OVWW36048	OVWW37248	OVWW38448	OVWW310848
52"	51 1/2"	45 1/4"	45 1/4"						
	OVWW47252	OVWW48052	OVWW49652	OVWW411252	OVWW35452	OVWW36052	OVWW37252	OVWW38452	OVWW310852
60"	59 1/2"	53 9/16"	53 1/4"						
	OVWW47260	OVWW48060	OVWW49660	OVWW411260	OVWW35460	OVWW36060	OVWW37260	OVWW38460	OVWW310860
66"	65 1/2"	58 1/4"	58 1/4"						
	OVWW47266	OVWW48066	OVWW49666	OVWW411266	OVWW35466	OVWW36066	OVWW37266	OVWW38466	OVWW310866
72"	71 1/2"	65 1/4"	65 1/4"						
	OVWW47272	OVWW48072	OVWW49672	OVWW411272	OVWW35472	OVWW36072	OVWW37272	OVWW38472	OVWW310872

Quad Casement Horizontal Detail

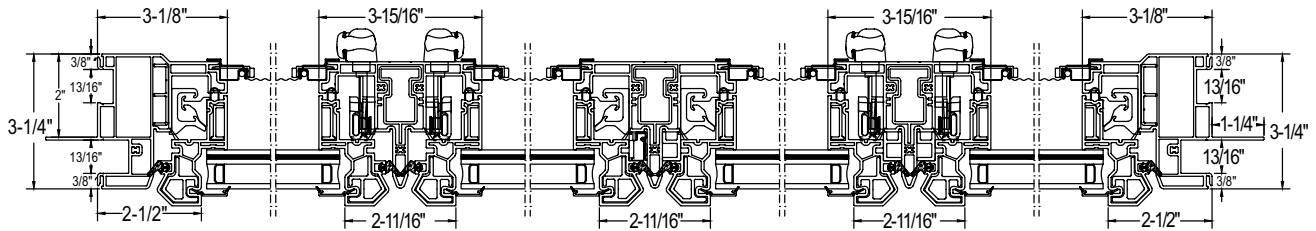

Casement/Picture/Casement Horizontal Detail

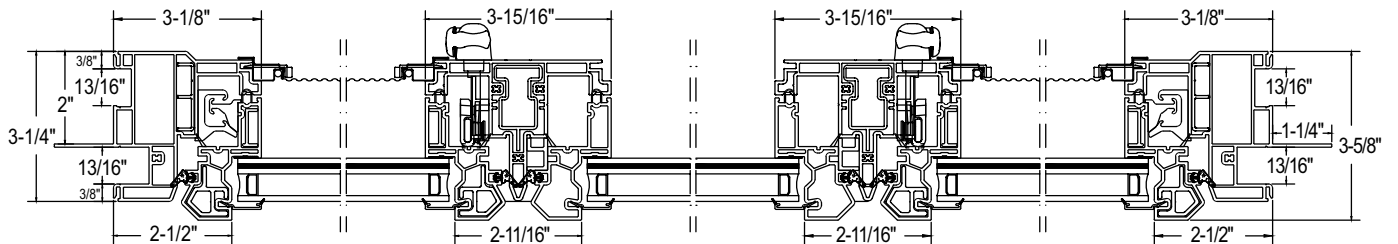

Callout sizes are expressed in inches and equal rough opening.
 Casement have an interior frame depth of 2" and an exterior projection of 1-5/8" from the nail fin.
 When mulling a unit to a casement, overall rough opening is not affected by the mullion.

- Meets egress of:
 Clear openable area ≥ 5.7 sq. ft.
 Clear openable width ≥ 20"
 Clear openable height ≥ 24"
- All sizes shown meet DP50 rating.
 For the latest testing data, contact Customer Service or visit our website at www.Viwinco.com.

Colonial casement grid pattern option available for single casements and twin casement sizes.
 Colonial casements are designed to mimic the look of double-hung and single-hung windows but offer the larger opening of a casement. To order: Single casement - use the callout prefix OCCX. Twin casement - use the callout prefix OTCCX. Consult Customer Service for the exact grid pattern. Final grid layout to be approved by customer.

OceanView Casement & Awning | Window Sizes and Detail Drawings

Rough Opening		Casement Picture (Fixed)				
		20"	24"	28"	30"	36"
Unit Size		19 1/2"	23 1/2"	27 1/2"	29 1/2"	35 1/2"
Visible Glass		13 1/4"	17 1/4"	21 1/4"	23 1/4"	29 1/4"
36"	35 1/2"					
	29 1/4"	OVCSMTPX2036	OVCSMTPX2436	OVCSMTPX2836	OVCSMTPX3036	OVCSMTPX3636
42"	41 1/2"					
	35 1/4"	OVCSMTPX2042	OVCSMTPX2442	OVCSMTPX2842	OVCSMTPX3042	OVCSMTPX3642
48"	47 1/2"					
	41 1/4"	OVCSMTPX2048	OVCSMTPX2448	OVCSMTPX2848	OVCSMTPX3048	OVCSMTPX3648
52"	51 1/2"					
	45 1/4"	OVCSMTPX2052	OVCSMTPX2452	OVCSMTPX2852	OVCSMTPX3052	OVCSMTPX3652
60"	59 1/2"					
	53 1/4"	OVCSMTPX2060	OVCSMTPX2460	OVCSMTPX2860	OVCSMTPX3060	OVCSMTPX3660
66"	65 1/2"					
	59 1/4"	OVCSMTPX2066	OVCSMTPX2466	OVCSMTPX2866	OVCSMTPX3066	OVCSMTPX3666
72"	71 1/2"					
	65 1/4"	OVCSMTPX2072	OVCSMTPX2472	OVCSMTPX2872	OVCSMTPX3072	OVCSMTPX3672

Rough Opening		Awning					
		24"	36"	40"	48"	56"	60"
Unit Size		23 1/2"	35 1/2"	39 1/2"	47 1/2"	55 1/2"	59 1/2"
Visible Glass		17 1/4"	29 1/4"	33 1/4"	41 1/4"	49 1/4"	53 1/4"
18"	17 1/2"						
	11 1/4"	OVAW2418	OVAW3618	OVAW4018	OVAW4818	OVAW5618	OVAW6018
20"	19 1/2"						
	13 1/4"	OVAW2420	OVAW3620	OVAW4020	OVAW4820	OVAW5620	OVAW6020
24"	23 1/2"						
	17 1/4"	OVAW2424	OVAW3624	OVAW4024	OVAW4824	OVAW5624	OVAW6024
28"	27 1/2"						
	21 1/4"	OVAW2428	OVAW3628	OVAW4028	OVAW4828	OVAW5628	OVAW6028
36"	35 1/2"						
	29 1/4"	OVAW2436	OVAW3636	OVAW4036	OVAW4836	OVAW5636	OVAW6036

Callout sizes are expressed in inches and equal rough opening.

Casement and awning windows have an interior frame depth of 2" and an exterior projection of 1-5/8" from the nail fin.

When mulling a unit to a casement or awning, overall rough opening is not affected by the mullion.

All sizes shown meet DP50 rating.

For the latest testing data, contact Customer Service or visit our website at www.viwinco.com.

Casement Picture (Fixed)
Cross-Sectional Head & Sill Detail

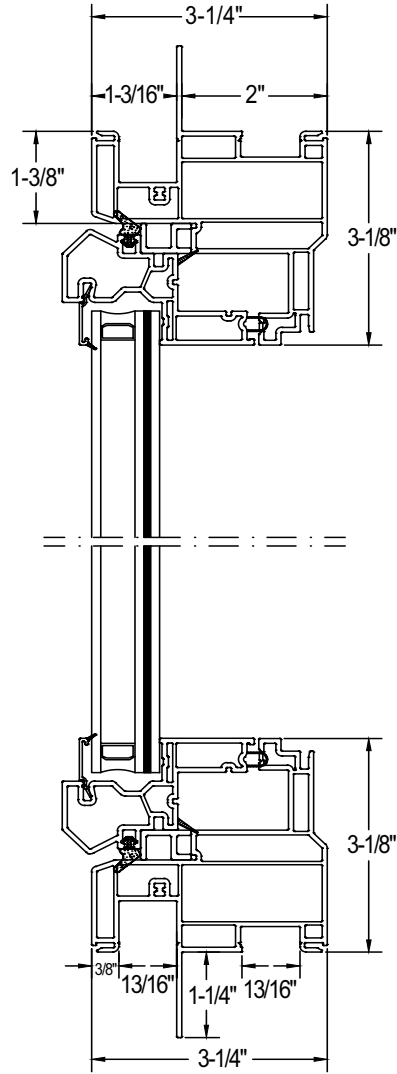

Awning Cross-Sectional Jamb Detail

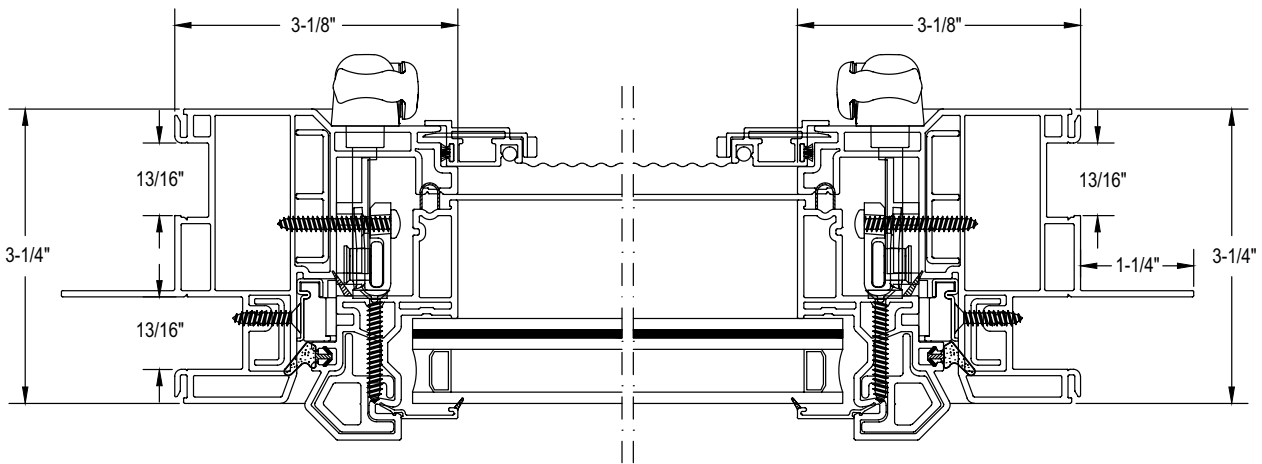

OceanView Patio Door | Window Sizes and Detail Drawings

Rough Opening		Patio Door - 2-Panel (XO/OX)		
		60"	72"	96"
Unit Size		59 ½"	71 ½"	95 ½"
80"	79 ½"			
		OVPD26080	OVPD27280	OVPD29680
82"	81 ½"			
		OVPD26082	OVPD27282	OVPD29682
96"	95 ½"			
		OVPD26096	OVPD27296	OVPD29696
<i>KD Assembly Available</i>				

Rough Opening		Patio Door - 3-Panel - Vinyl Sill (OXO)		
		90"	108"	144"
Unit Size		89 ½"	107 ½"	143 ½"
80"	79 ½"			
		OVPD39080	OVPD310880	OVPD314480●
82"	81 ½"			
		OVPD39082	OVPD310882	OVPD314482●
96"	95 ½"			
		OVPD39096	OVPD310896●	OVPD314496●
<i>KD Assembly Available</i>				

Callout sizes are expressed in inches and equal rough opening.

Patio doors have an interior frame depth of 3-3/8" and an exterior projection of 1-1/2" from the nail fin.

Patio doors are not field reversible.

Two-point lock with adjustable strikes on all patio doors.



● KD assembly only

☐ All sizes shown meet DP50 rating.

For the latest testing data, contact Customer Service or visit our website at www.Viwinco.com.

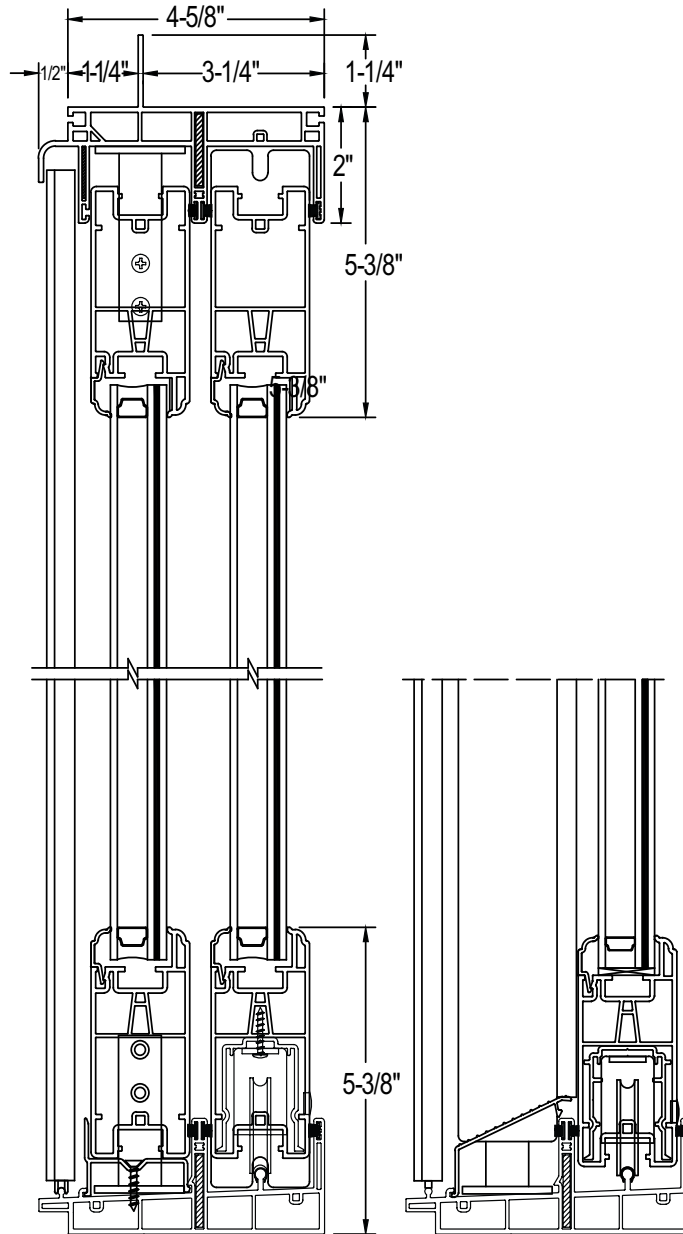
Patio Door – 2-Panel - Vinyl Sill
Sectional Head & Sill Detail

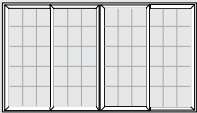
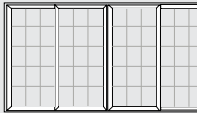
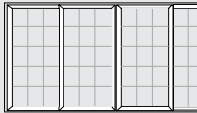
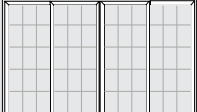

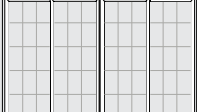
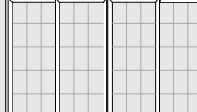
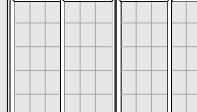
Rough Opening		Patio Door - 4-Panel - Vinyl Sill (OXXO)		
		118"	144"	192"
Unit Size		117 1/2"	143 1/2"	191 1/2"
80"	79 1/2"	 OVPD411880●	 OVPD414480●	 OVPD419280●
	82"	 OVPD411882●	 OVPD414482●	 OVPD419282●
	96"	 OVPD411896●	 OVPD414496●	 OVPD419296●

ONLY KD Assembly Available

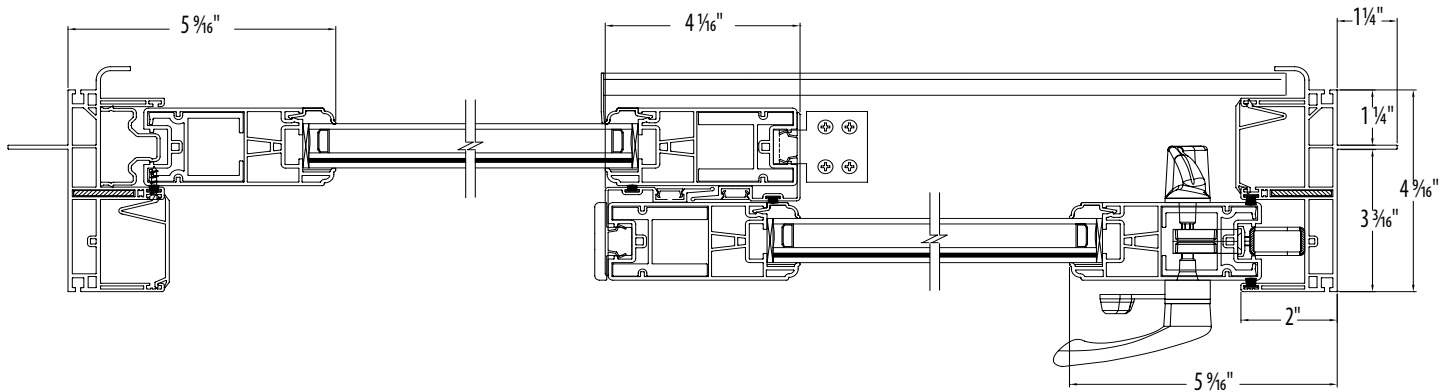

Patio Door Cross-Sectional Jamb Detail



Callout sizes are expressed in inches and equal rough opening.
 Patio doors have an interior frame depth of 3-3/8" and an exterior projection of 1-1/2" from the nail fin.
 Patio doors are not field reversible.
 Two-point lock with adjustable strikes on all patio doors.

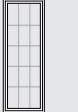
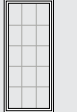
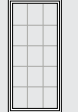
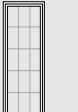
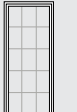
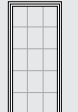

- KD assembly only
- ☐ All sizes shown meet DP50 rating.

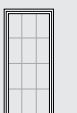
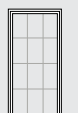
For the latest testing data, contact Customer Service or visit our website at www.Viwinco.com.

Rough Opening	Patio Door Sidelite			
	32"	38"	42"	48"
Unit Size	31 1/2"	37 1/2"	41 1/2"	47 1/2"
80"	79 1/2"			
		OVPDSL3280	OVPDSL3880	OPDSL4280
82"	81 1/2"			
		OVPDSL3282	OVPDSL3882	OPDSL4282
96"	95 1/2"			
		OVPDSL3296	OVPDSL3896	OPDSL4296

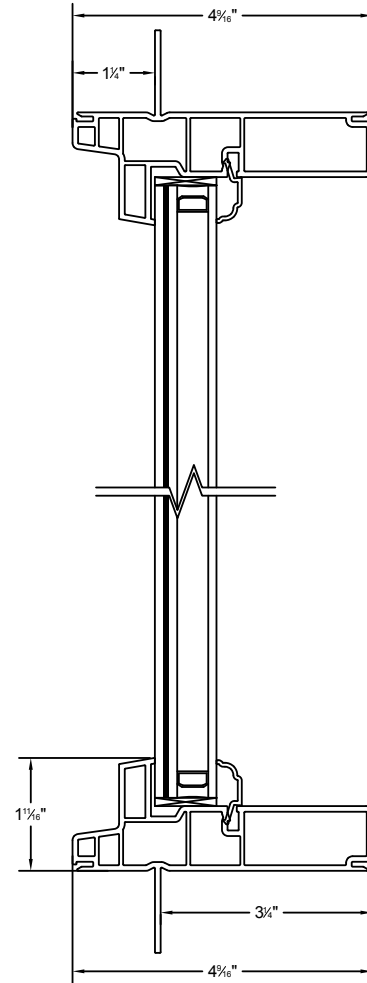
Sidelites and Transoms
Vertical Detail

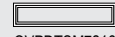

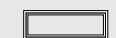
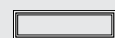
Rough Opening	Patio Door Transom		
	60"	72"	96"
Unit Size	59 1/2"	71 1/2"	95 1/2"
16"	15 1/2"		
		OVPDTSM6016	OVPDTSM7216
20"	19 1/2"		
		OVPDTSM6020	OVPDTSM7220
24"	23 1/2"		
		OVPDTSM6024	OVPDTSM7224

Callout sizes are expressed in inches and equal rough opening.



Casement and awning windows have an interior frame depth of 2" and an exterior projection of 1-5/8" from the nail fin.



When mulling a unit to a casement or awning, overall rough opening is not affected by the mullion.

All sizes shown meet DP50 rating.

For the latest testing data, contact Customer Service or visit our website at www.Viwinco.com.

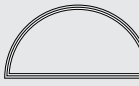
OceanView Patio Door Geometric Shapes | Window Sizes and Detail Drawings

Rough Opening		Geometric shapes for patio doors — Half-Round					
		60"	72"	96"			
Unit Size		59 1/2"	71 1/2"	95 1/2"			
30"	29 1/2"	 OVPDHRND6030					
	36"				35 1/2"	 OVPDHRND7236	
48"	47 1/2"				 OVPDHRND9648		

Rough Opening		Geometric shapes for patio doors — Elliptical					
		60"	72"	96"			
Unit Size		59 1/2"	71 1/2"	95 1/2"			
18"	17 1/2"	 OVPDELLIP6018					
	20"				19 1/2"	 OVPDELLIP7220	
 OVPDELLIP9620							

Grid Patterns for Geometric Shapes — Half-Round

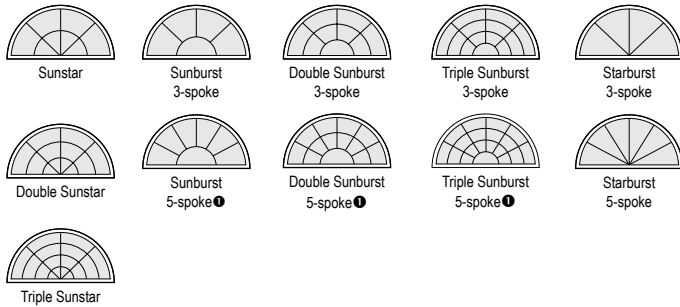

Grid Patterns for Geometric Shapes — Elliptical

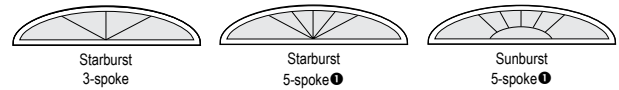

Callout sizes are expressed in inches and equal rough opening.

Patio doors have an interior frame depth of 3-3/8" and an exterior projection of 1-1/2" from the nail fin.

Transoms and sidelites have an interior frame depth of 3-3/8" and an exterior projection of 1-3/8" from the nail fin.

When mulling a transom or sidelite to a patio door, add 1" to the overall rough opening total unit dimension for each mullion.

Patio doors are not field reversible. Two-point lock with adjustable strikes on all patio doors.

● 5-spoke starburst pattern: Minimum window size is 60" for either deluxe or flat grids.

NOTE: Direct-set glazing is set directly into the frame for more glass area in the opening.

☐ All sizes shown meet DP50 rating.

For the latest testing data, contact Customer Service or visit our website at www.Viwinco.com.

3.5" Flat Casing Picture Frame w/ Pocket Filler Vertical Detail

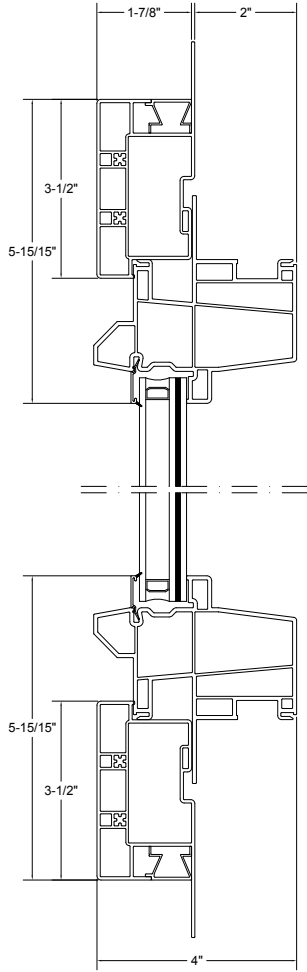

Brick Mold Casing w/ Bullnose Sill and Pocket Filler Vertical Detail

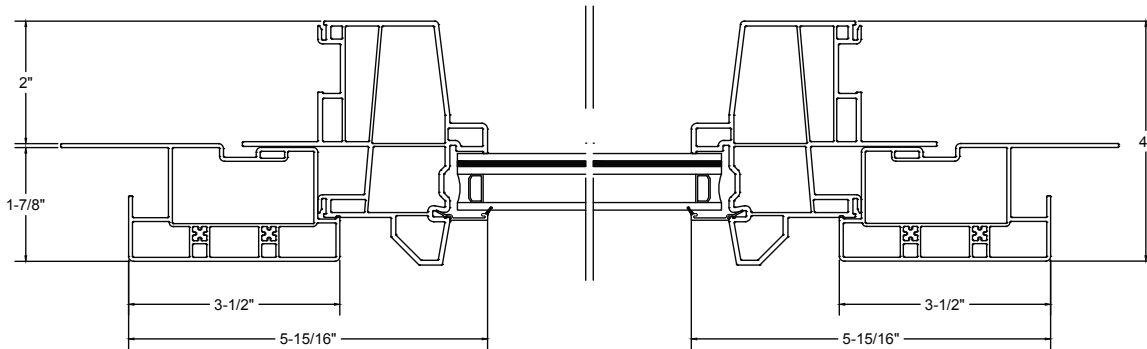
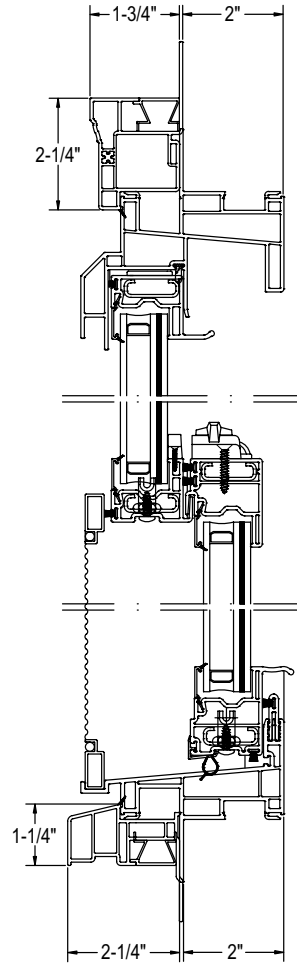

**3.5" Flat Casing
w/o Pocket Filler
Horizontal Detail**

**Brick Mold Casing
w/o Pocket Filler
Horizontal Detail**

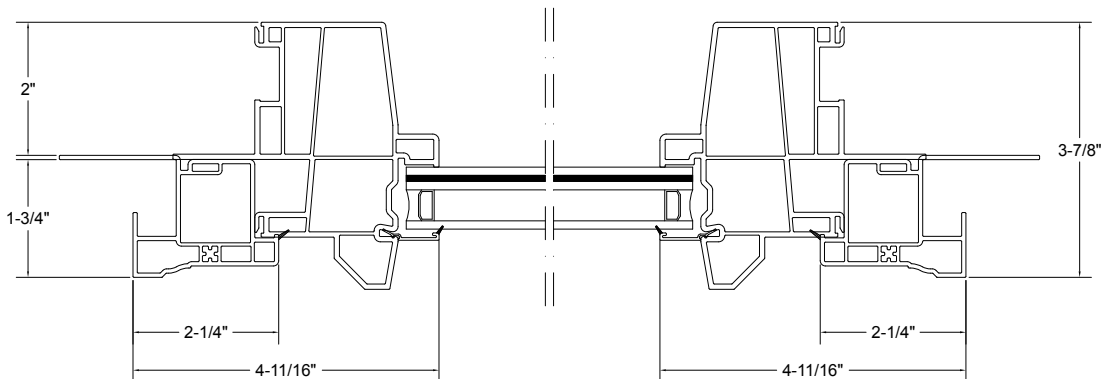



851 Hemlock Road

Morgantown, PA 19543

Visit us at www.Viwinco.com

4/2026